

FAI

AEROBATICS COMMISSION

WGAC 2018

Form B

Pilot ID

CIVA Glider Unlimited FreeUnknown

A

Flight #

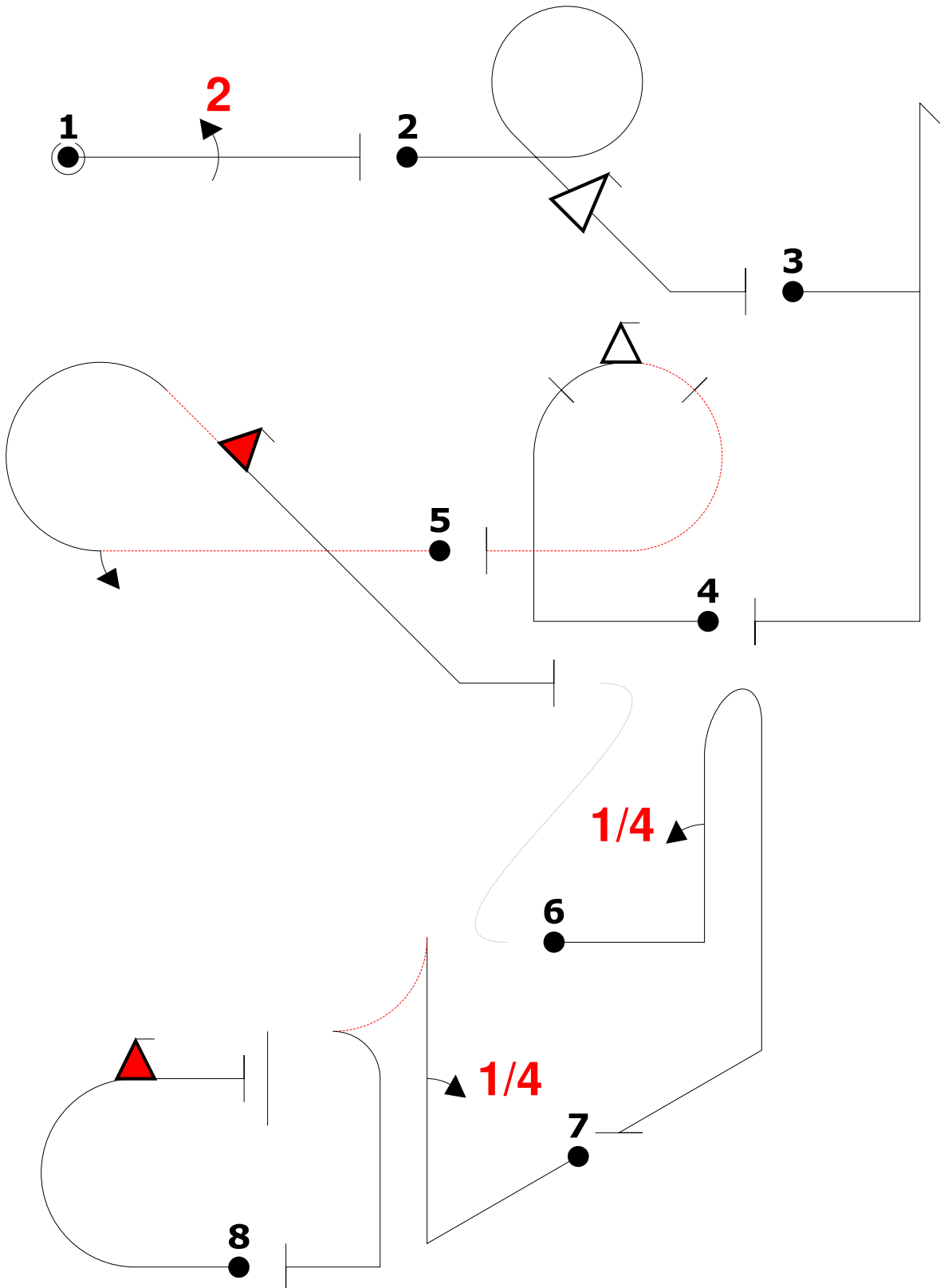



| | | |
|------------------|-----------------------------------|-------------------|
| Zbraslavice 2018 | | Form B |
| Pilot ID | CIVA Glider Unlimited FreeUnknown | Flight # B |

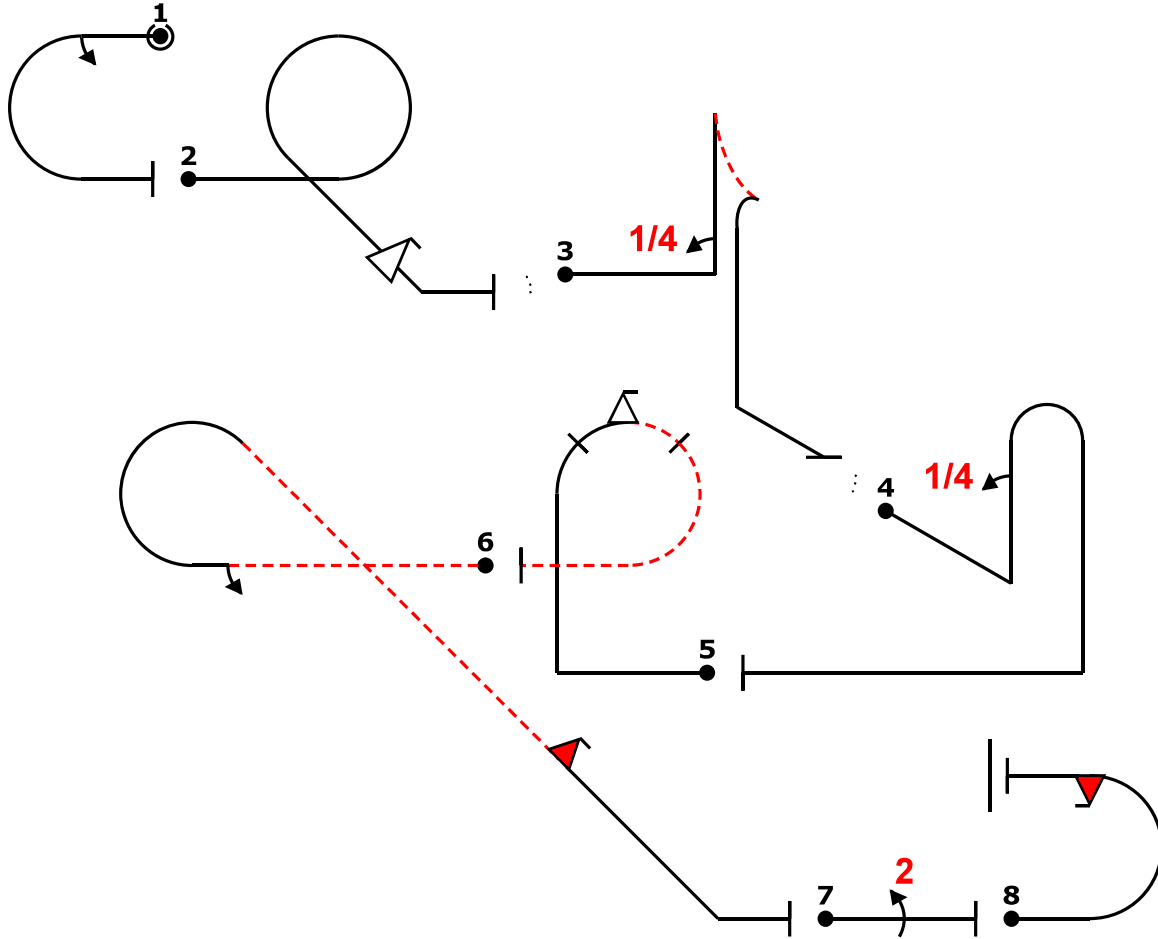
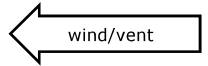

| Glider | | | |
|---------------------------------------|--------------------------------|---------------|----|
| Fig 1 | 7.2.3.3 9.1.3.2 | 6 6 | 12 |
| Fig 2 | 8.7.5.1 9.9.4.4 | 11 16 | 27 |
| Fig 3 | 6.2.2.1 9.1.1.1 | 17 9 | 26 |
| Fig 4 | 8.4.1.1 9.1.1.1 | 13 9 | 22 |
| Fig 5 | 8.6.17.1 9.9.3.2 | 14 12 | 26 |
| Fig 6 | 8.5.8.2 9.1.3.2 9.10.4.2 | 11 6 15 | 32 |
| Fig 7 | 1.1.1.1 9.2.3.4 | 2 14 | 16 |
| Fig 8 | 7.2.2.1 9.10.8.2 | 6 18 | 24 |
| Total K = 185 (max K = 200) | | | |

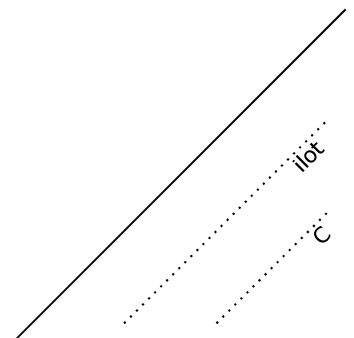

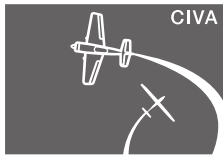

FAI

AEROBATICS COMMISSION

| | | |
|----------|-----------------------------------|----------|
| | | Form B |
| Pilot ID | CIVA Glider Unlimited FreeUnknown | C |
| | | Flight # |

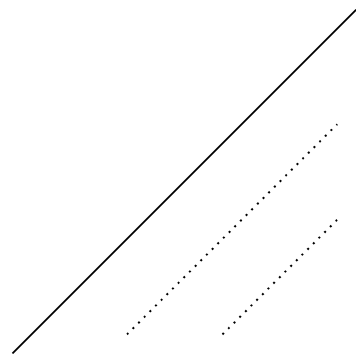
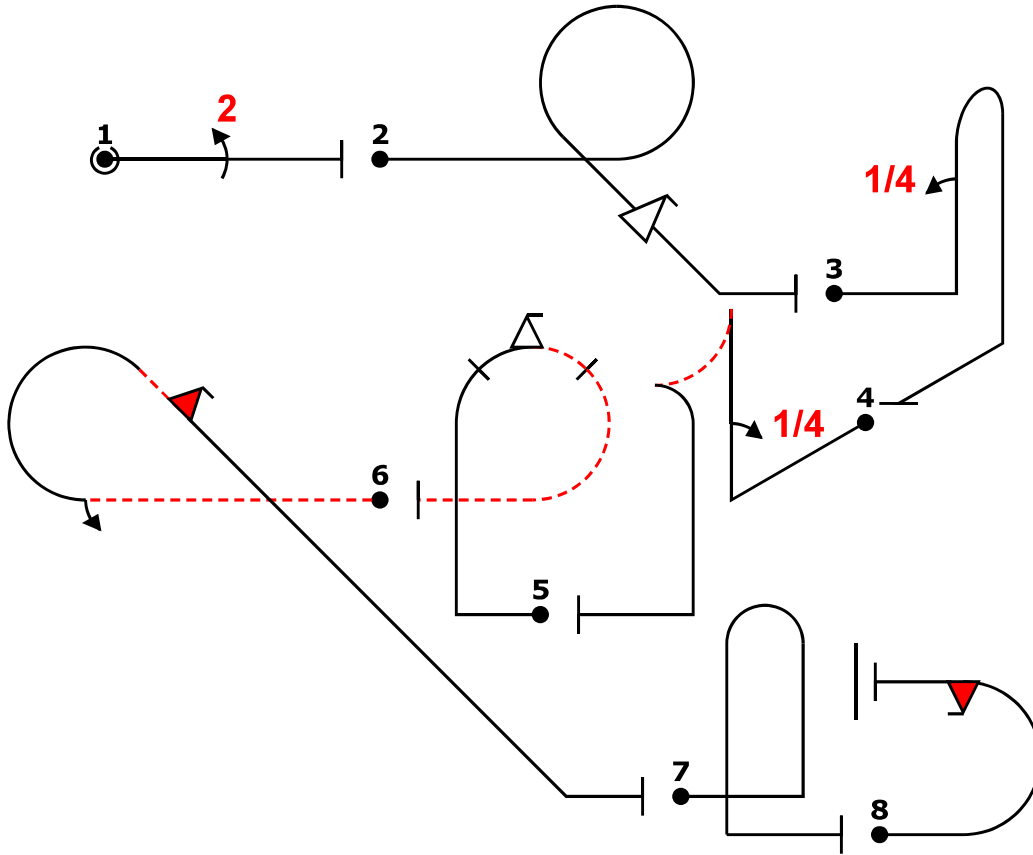
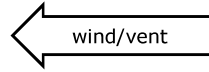

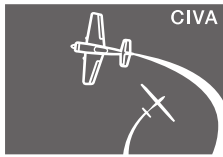

FAI

AEROBATICS COMMISSION

| | | |
|----------|-----------------------------------|----------|
| | | Form B |
| Pilot ID | CIVA Glider Unlimited FreeUnknown | Flight # |
| | | D |

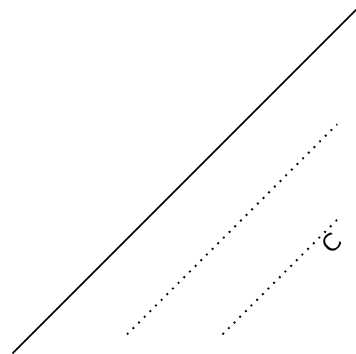
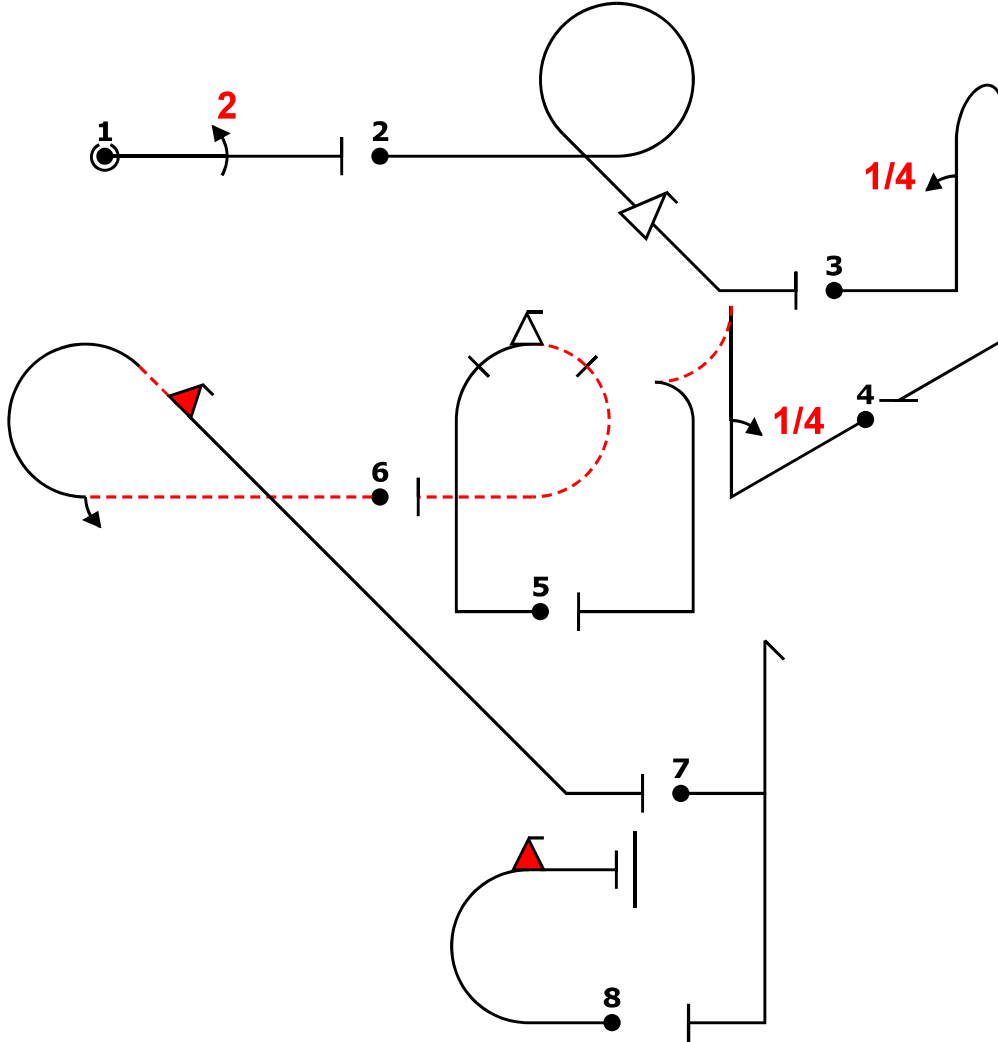
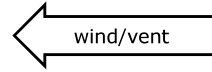

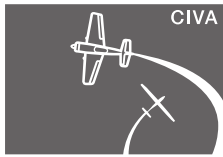

FAI

AEROBATICS COMMISSION

Pilot ID

CIVA Glider Unlimited FreeUnknown

Form B

Flight #

E

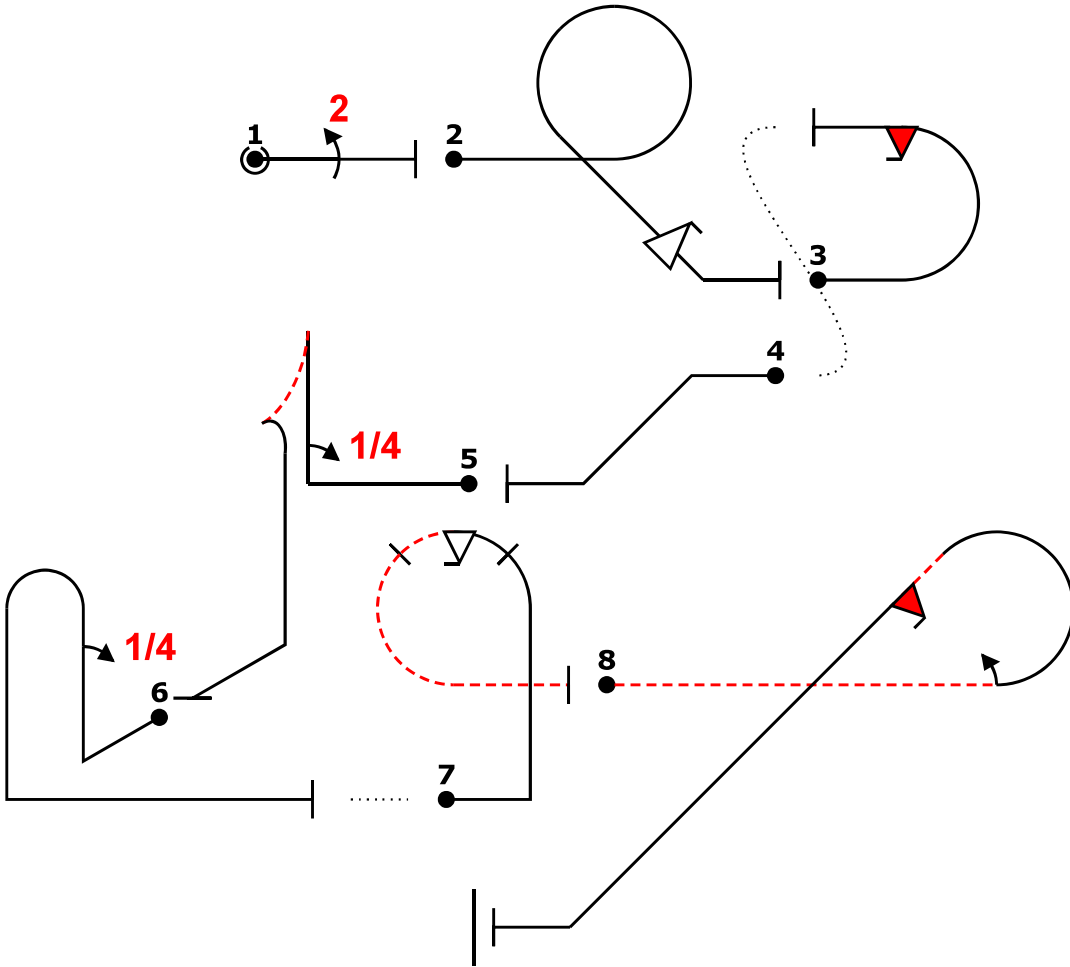
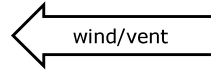

 Pilot
 A/C

Pilot ID

CIVA Glider Unlimited FreeUnknown

F

Flight #

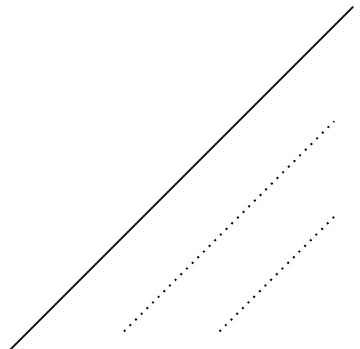
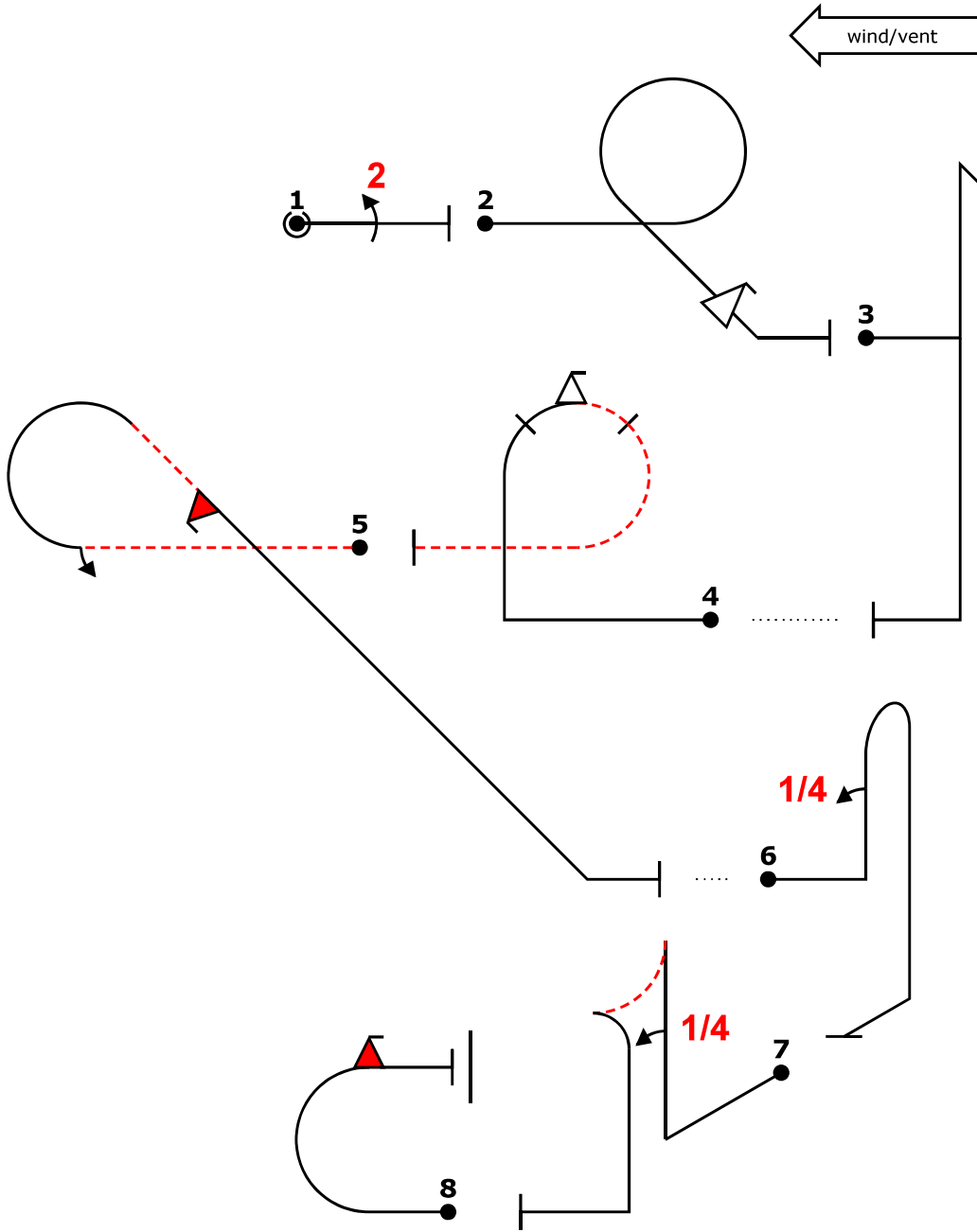

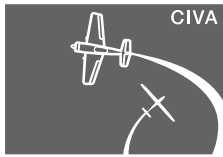

FAI

AEROBATICS COMMISSION

WGAC 2018

Form B

Pilot ID

CIVA Glider Unlimited FreeUnknown

G

Flight #

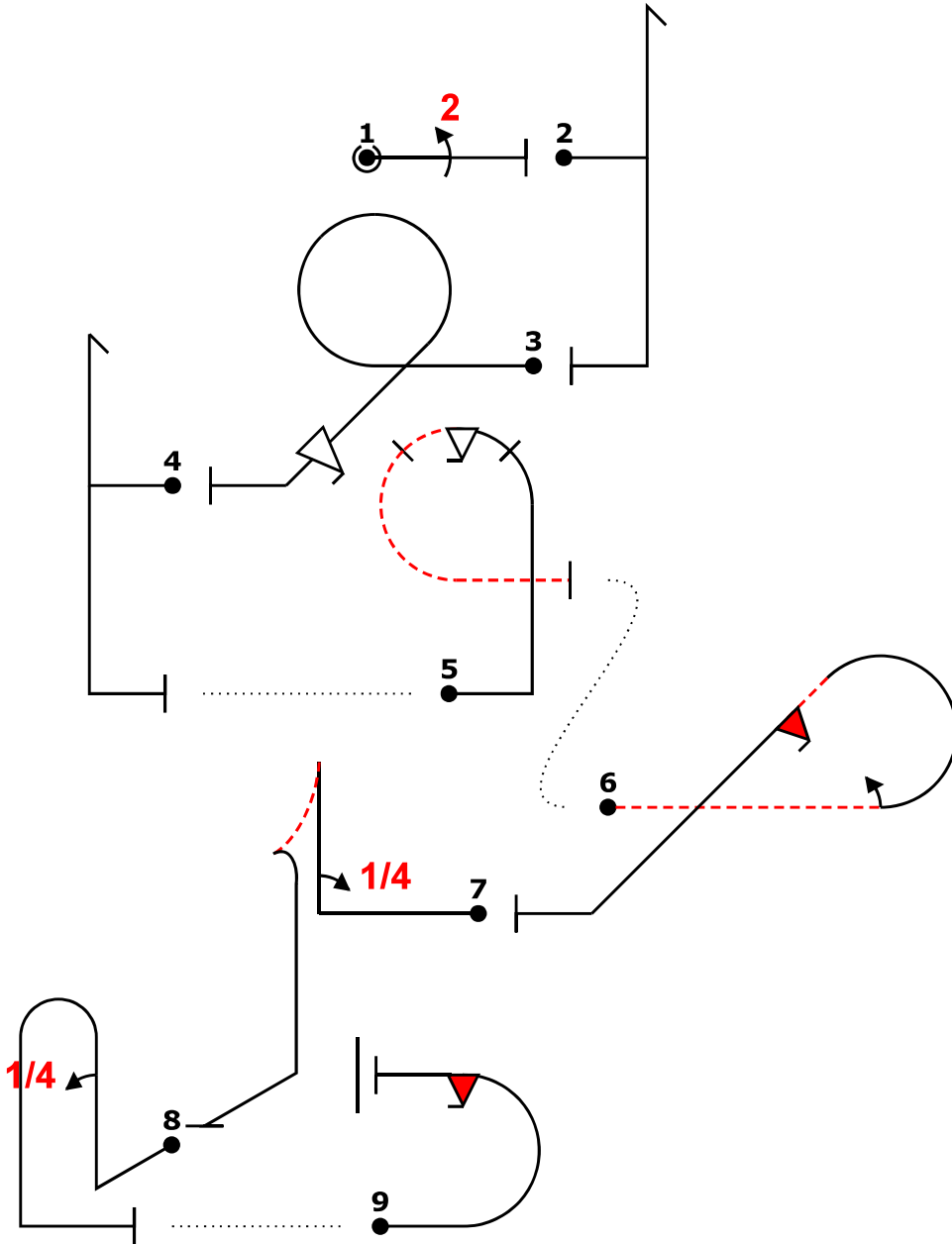
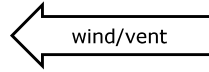

 Pilot
 A/C



| | | |
|-------------|--|----------|
| Zbraslavice | | Form B |
| Pilot ID | CIVA Glider Unlimited FreeUnknown H | Flight # |

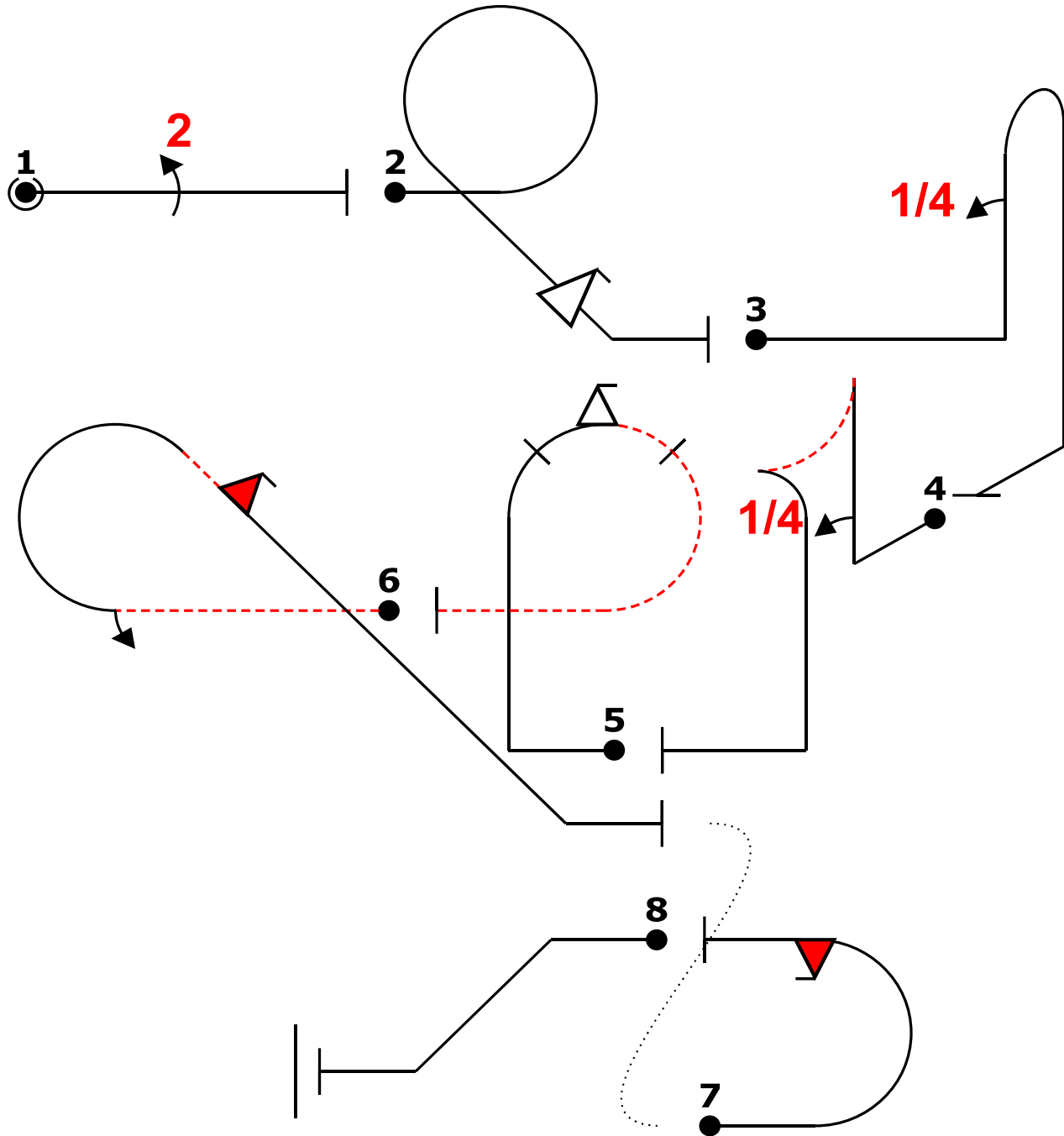

Check: 4-8-2018 12:39 OpenAero 2018.3.8 2018 glider-civa unlimited freeunknown Sequence is correct
 "8A" '122+ "8B" ""qf "8C" -+4b." "8D" ""+4ita"" "8E" xp(2f)-- "8F" -""2c2if..." (-2,13) "8G" m2if "8L" id

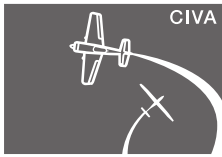

FAI

AEROBATICS
COMMISSION

| | | |
|----------|-----------------------------------|----------------------|
| | | Form B |
| Pilot ID | CIVA Glider Unlimited FreeUnknown | Flight # I |

