

CIVA

FAI

AEROBATICS COMMISSION

EAAC 2019 1st - 10th Aug

Form B

Pilot ID

CIVA Advanced Unknown1

Flight #

LTU

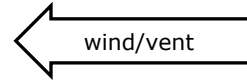

A

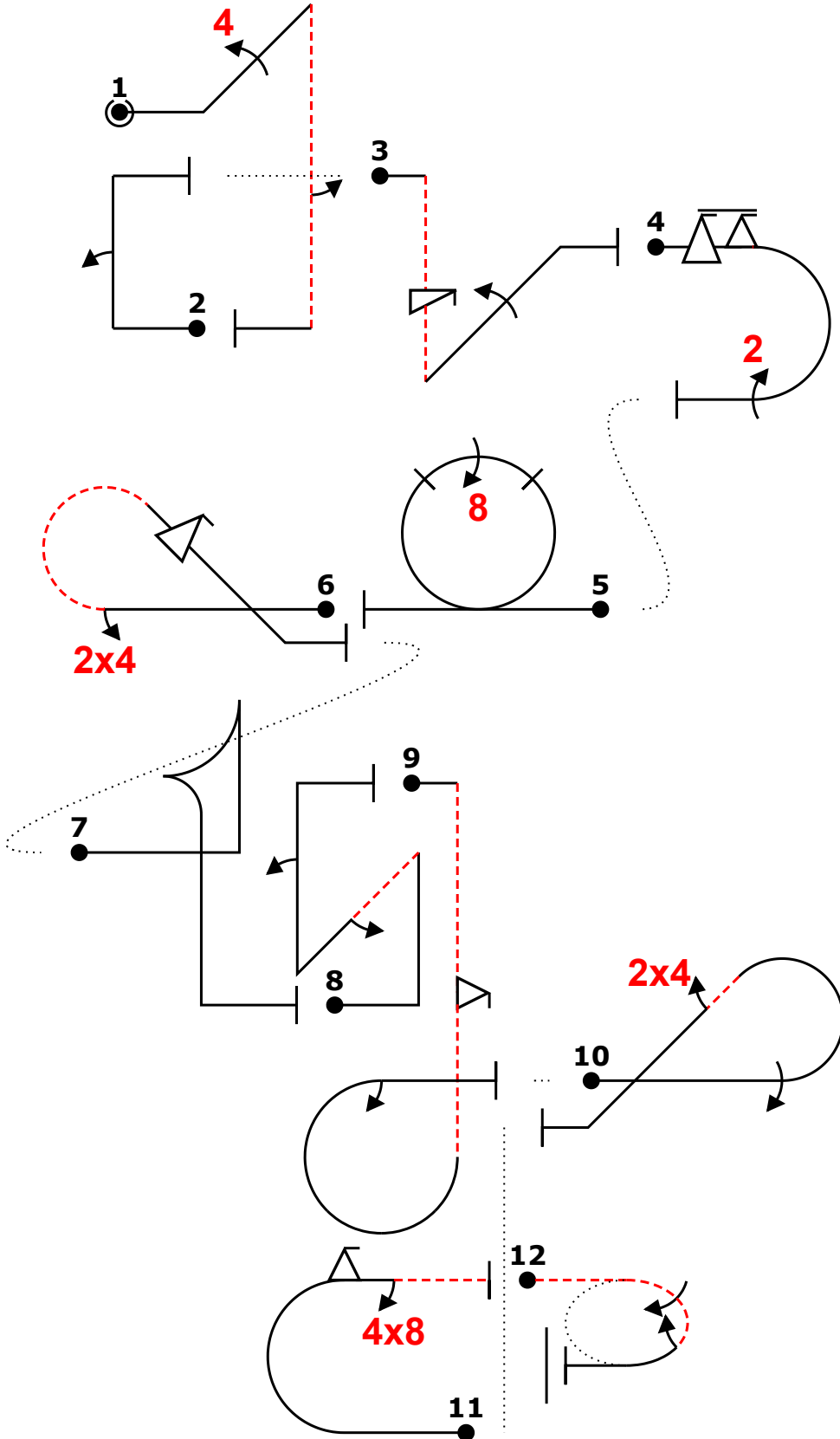

Power			
Fig	Aresti	K	
1 G	1.2.1.1	13	30
	9.4.2.4	13	
	9.1.5.2	4	
2 Add.	1.1.6.1	10	12
	9.1.1.2	8	
3 D	1.2.6.3	15	30
	9.11.1.4	5	
	9.1.2.4	10	
4 A	7.2.3.3	6	29
	9.9.3.6	14	
	9.2.3.4	9	
5 C	7.4.1.1	10	25
	9.8.3.4	15	
6 J	8.5.7.1	12	28
	9.4.3.2	5	
	9.9.4.4	11	
7 I	6.2.1.1	15	15
8 Add.	1.3.12.1	21	12
	9.1.4.2	4	
	9.1.1.2	8	
9 E	8.6.4.3	13	30
	9.9.10.2	13	
	9.1.3.2	4	
10 F	8.5.6.1	10	23
	9.1.3.4	8	
	9.4.4.2	5	
11 B	7.2.1.1	6	24
	9.9.3.2	11	
	9.8.3.2	7	
12 H	2.2.3.2	24	24
Total K = 282			

Pilot
A/C

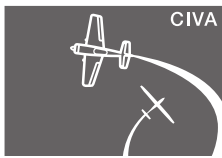

FAI
AEROBATICS
COMMISSION

EAAC 2019 1st - 10th August

Form B

Pilot ID

CIVA Advanced Programme2

Flight #

ROM

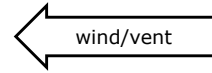

B

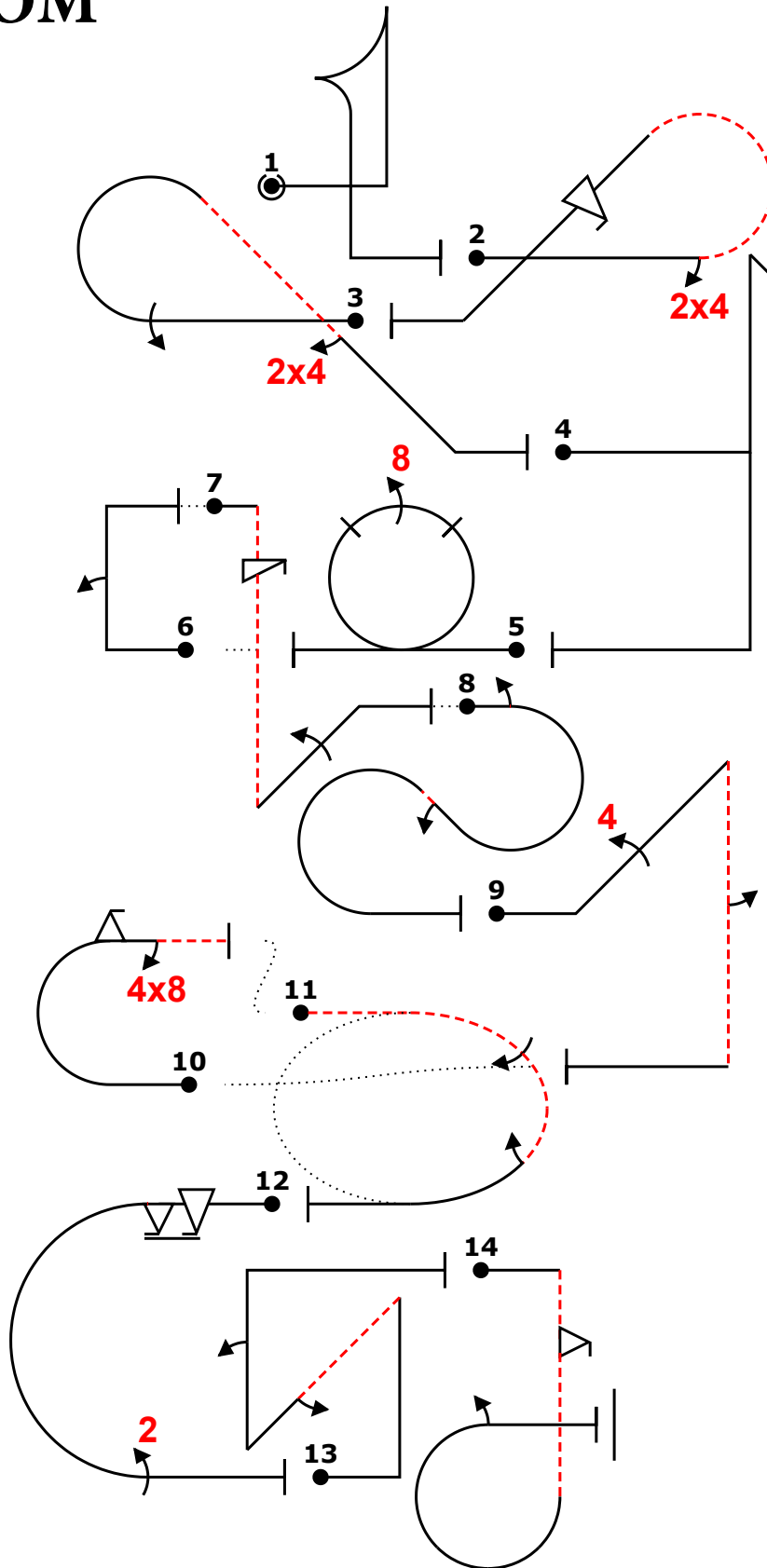

Power			
Fig	Aresti	K	
1 I	6.2.1.1	15	15
2 J	8.5.7.1	12	28
	9.4.3.2	5	
	9.9.4.4	11	
3 F	8.5.6.1	10	23
	9.1.3.4	8	
	9.4.4.2	5	
4 Add.	5.2.1.1	17	6
5 C	7.4.1.1	10	25
	9.8.3.4	15	
6 Add.	1.1.6.1	10	6
	9.1.1.2	8	
7 D	1.2.6.3	15	30
	9.11.1.4	5	
	9.1.2.4	10	
8 Add.	7.5.5.3	15	6
	9.1.3.2	4	
	9.1.2.2	6	
9 G	1.2.1.1	13	30
	9.4.2.4	13	
	9.1.5.2	4	
10 B	7.2.1.1	6	24
	9.9.3.2	11	
	9.8.3.2	7	
11 H	2.2.3.2	24	24
12 A	7.2.3.3	6	29
	9.9.3.6	14	
	9.2.3.4	9	
13 Add.	1.3.12.1	21	6
	9.1.4.2	4	
	9.1.1.2	8	
14 E	8.6.4.3	13	30
	9.9.10.2	13	
	9.1.3.2	4	
Total K = 282			

Pilot
A/C

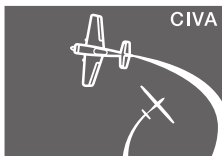

CIVA

FAI

AEROBATICS COMMISSION

EAAC 2019 1st - 10th August

Form B

Pilot ID

CIVA Advanced Programme2

Flight #

ROM

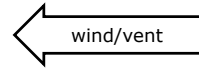

C

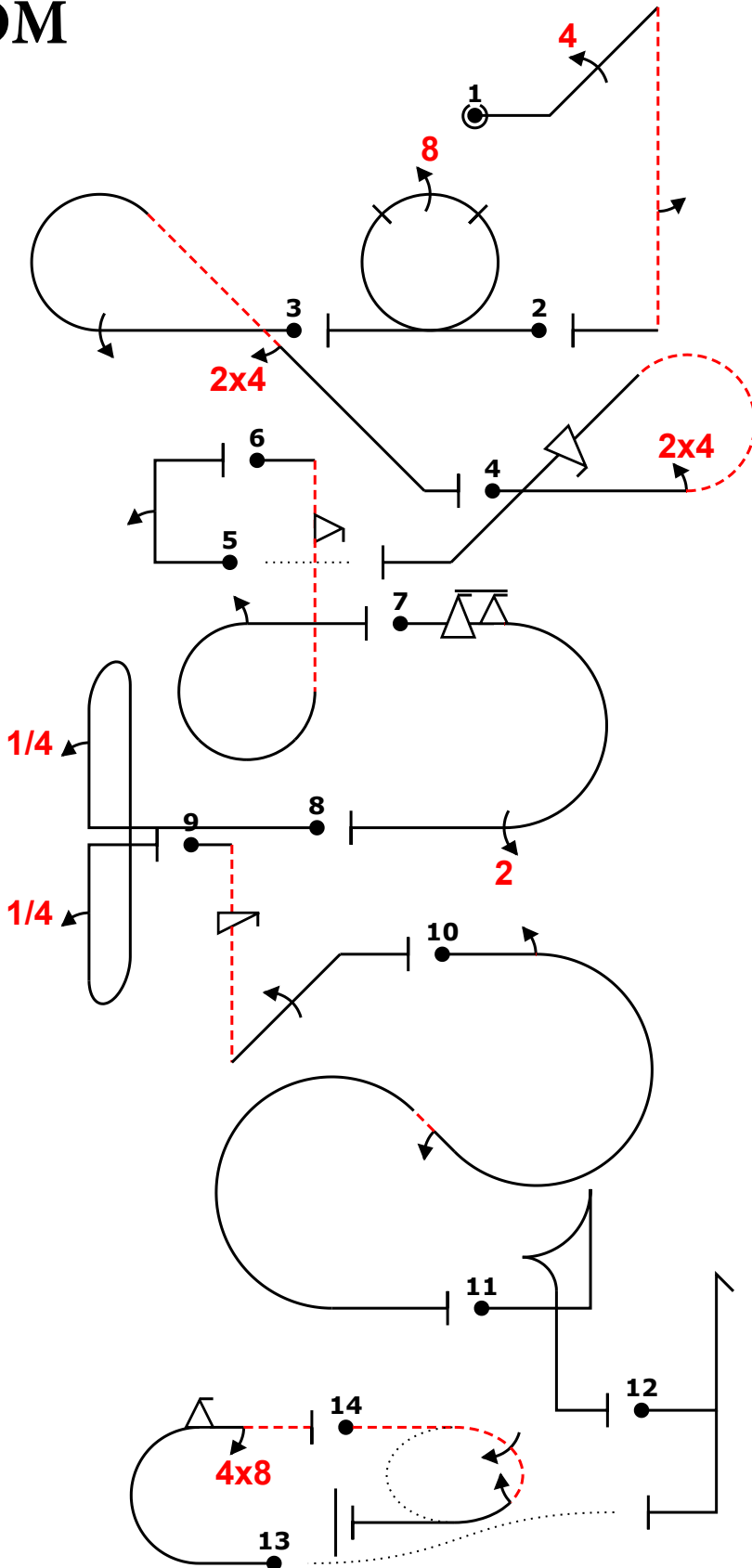

Power			
Fig	Aresti	K	
1 G	1.2.1.1	13	30
	9.4.2.4	13	
	9.1.5.2	4	
2 C	7.4.1.1	10	25
	9.8.3.4	15	
3 F	8.5.6.1	10	23
	9.1.3.4	8	
	9.4.4.2	5	
4 J	8.5.7.1	12	28
	9.4.3.2	5	
	9.9.4.4	11	
5 Add.	1.1.6.1	10	6
	9.1.1.2	8	
6 E	8.6.4.3	13	30
	9.9.10.2	13	
	9.1.3.2	4	
7 A	7.2.3.3	6	29
	9.9.3.6	14	
	9.2.3.4	9	
8 Add.	8.8.2.1	19	6
	9.1.1.1	6	
	9.1.1.1	6	
9 D	1.2.6.3	15	30
	9.11.1.4	5	
	9.1.2.4	10	
10 Add.	7.5.5.3	15	6
	9.1.3.2	4	
	9.1.2.2	6	
11 I	6.2.1.1	15	15
12 Add.	5.2.1.1	17	6
13 B	7.2.1.1	6	24
	9.9.3.2	11	
	9.8.3.2	7	
14 H	2.2.3.2	24	24
Total K = 282			

Pilot
A/C



FRA

D

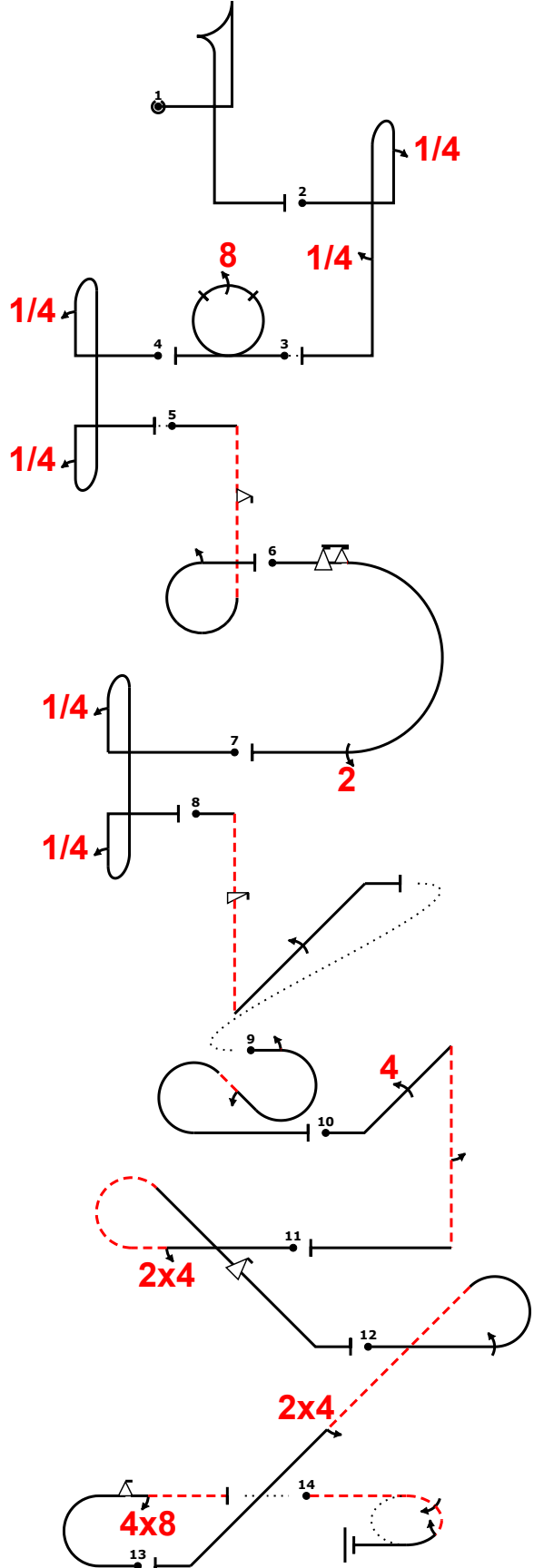

wind/vent ←

Power		
Fig	Aresti	K
1	6.2.1.1	15
1		15
2	8.4.1.1	13
	9.1.1.1	6
Add.	9.1.5.1	2
3	7.4.1.1	10
	9.8.3.4	15
		25
4	8.8.2.1	19
	9.1.1.1	6
Add.	9.1.1.1	6
5	8.6.4.3	13
	9.9.10.2	13
E	9.1.3.2	4
6	7.2.3.3	6
	9.9.3.6	14
A	9.2.3.4	9
7	8.8.2.1	19
	9.1.1.1	6
Add.	9.1.1.1	6
8	1.2.6.3	15
	9.11.1.4	5
D	9.1.2.4	10
9	7.5.5.3	15
	9.1.3.2	4
Add.	9.1.2.2	4
10	1.2.1.1	13
	9.4.2.4	13
G	9.1.5.2	4
11	8.5.7.1	12
	9.4.3.2	5
J	9.9.4.4	11
12	8.5.6.1	10
	9.1.3.4	8
F	9.4.4.2	5
13	7.2.1.1	6
	9.9.3.2	11
B	9.8.3.2	7
14	2.2.3.2	24
H		24
Total K =		282

Pilot

A/C



EAAC 2019 1st - 10th August		Form B
Pilot ID	CIVA Advanced Unknown1	
	Flight #	

USA

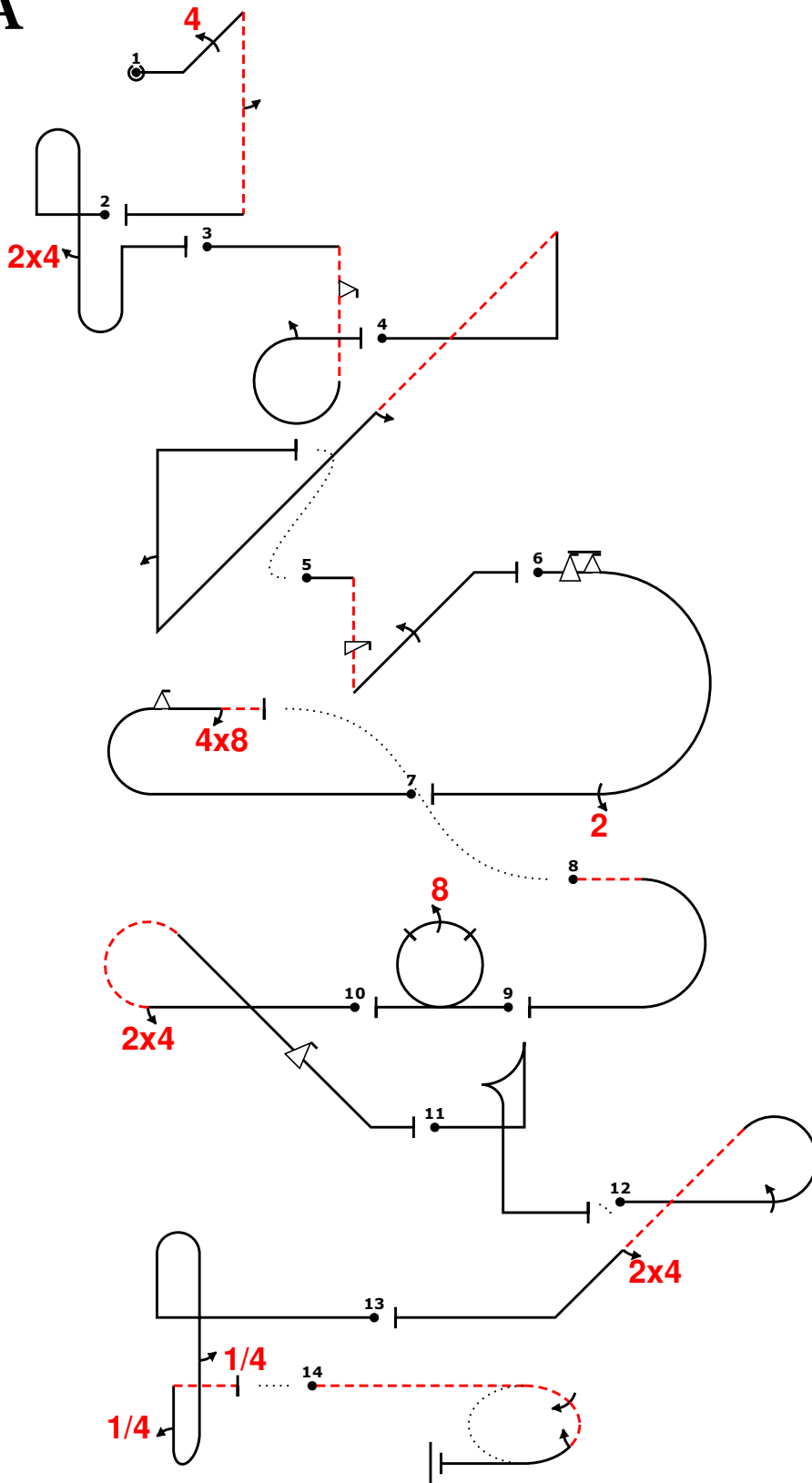

← wind/vent

Power			K
Fig	Aresti		
1 G	1.2.1.1	13	30
	9.4.2.4	13	
	9.1.5.2	4	
2 Add.	8.8.2.1	19	6
	9.4.5.2	5	
3 E	8.6.4.3	13	30
	9.9.10.2	13	
	9.1.3.2	4	
4 Add.	1.3.12.1	21	6
	9.1.4.2	4	
	9.1.1.2	8	
5 D	1.2.6.3	15	30
	9.11.1.4	5	
	9.1.2.4	10	
6 A	7.2.3.3	6	29
	9.9.3.6	14	
	9.2.3.4	9	
7 B	7.2.1.1	6	24
	9.9.3.2	11	
	9.8.3.2	7	
8 Add.	7.2.1.4	6	6
9 C	7.4.1.1	10	25
	9.8.3.4	15	
10 F	8.5.7.1	12	28
	9.4.3.2	5	
	9.9.4.4	11	
11 I	6.2.1.1	15	15
12 J	8.5.6.1	10	23
	9.1.3.4	8	
	9.4.4.2	5	
13 Add.	8.8.1.1	18	6
	9.1.5.1	2	
	9.1.1.1	6	
14 H	2.2.3.2	24	24
Total K = 282			

E

Check: 2-8-2019 15:32 OpenAero 2019.2.3 2019 civa advanced unknown1 Sequence is correct

 Pilot
 A/C



EAAC 2019 2nd - 10th August		Form B
Pilot ID	CIVA Advanced Unknown1	
	Flight #	

USA

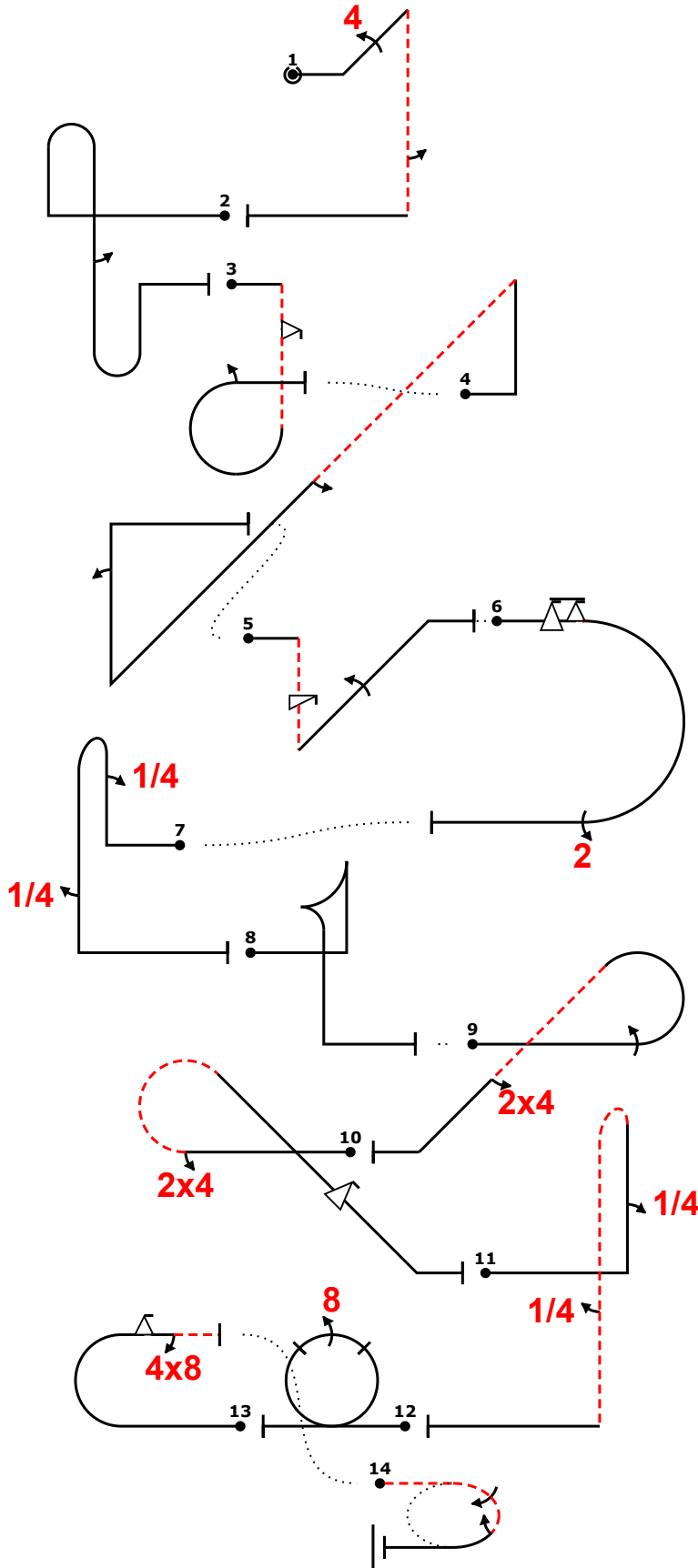

← wind/vent

Power			
Fig	Aresti	K	
1 G	1.2.1.1	13	30
	9.4.2.4	13	
	9.1.5.2	4	
2 Add.	8.8.2.1	19	6
	9.1.5.2	4	
3 E	8.6.4.3	13	30
	9.9.10.2	13	
	9.1.3.2	4	
4 Add.	1.3.12.1	21	6
	9.1.4.2	4	
	9.1.1.2	8	
5 D	1.2.6.3	15	30
	9.11.1.4	5	
	9.1.2.4	10	
6 A	7.2.3.3	6	29
	9.9.3.6	14	
	9.2.3.4	9	
7 Add.	8.4.1.1	13	6
	9.1.1.1	6	
	9.1.5.1	2	
8 I	6.2.1.1	15	15
9 F	8.5.6.1	10	23
	9.1.3.4	8	
	9.4.4.2	5	
10 J	8.5.7.1	12	28
	9.4.3.2	5	
	9.9.4.4	11	
11 Add.	8.4.3.1	15	6
	9.1.1.1	6	
	9.1.5.1	2	
12 C	7.4.1.1	10	25
	9.8.3.4	15	
13 B	7.2.1.1	6	24
	9.9.3.2	11	
	9.8.3.2	7	
14 H	2.2.3.2	24	24
Total K = 282			

F

Pilot
A/C

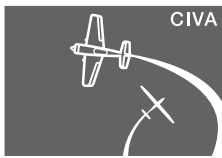

CIVA

FAI

AEROBATICS
COMMISSION

EAAC 2019 1st - 10th August

Form B

Pilot ID

CIVA Advanced Unknown1

Flight #

RUS

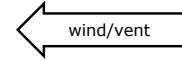

G

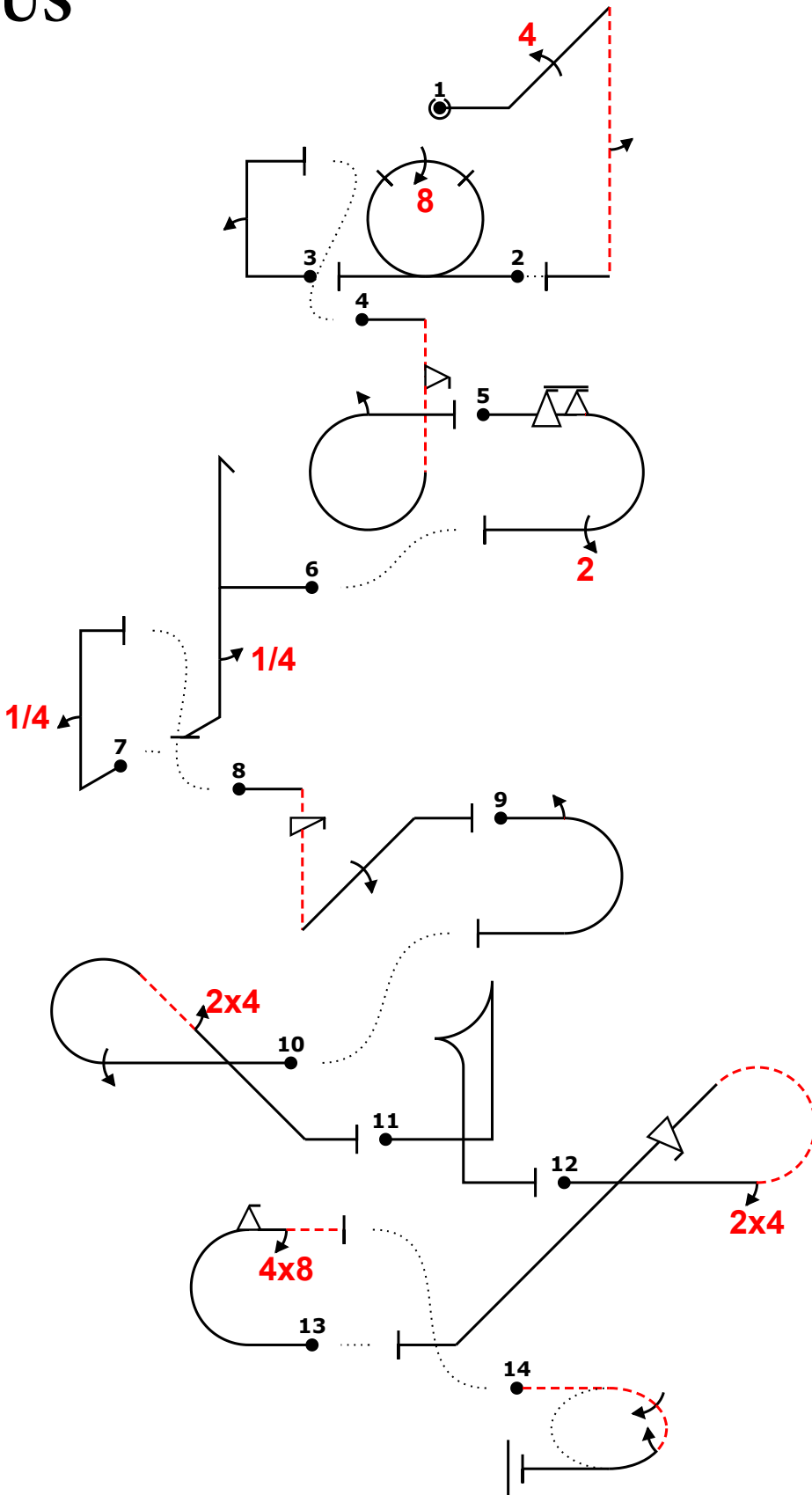

Power			
Fig	Aresti	K	
1 G	1.2.1.1	13	30
	9.4.2.4	13	
	9.1.5.2	4	
2 C	7.4.1.1	10	25
	9.8.3.4	15	
3 Add.	1.1.6.1	10	6
	9.1.1.2	8	
4 E	8.6.4.3	13	30
	9.9.10.2	13	
	9.1.3.2	4	
5 A	7.2.3.3	6	29
	9.9.3.6	14	
	9.2.3.4	9	
6 Add.	5.2.1.1	17	6
	9.1.5.1	2	
7 Add.	1.1.6.1	10	6
	9.1.1.1	6	
8 D	1.2.6.3	15	30
	9.11.1.4	5	
	9.1.2.4	10	
9 Add.	7.2.3.3	6	6
	9.1.3.2	4	
10 F	8.5.6.1	10	23
	9.1.3.4	8	
	9.4.4.2	5	
11 I	6.2.1.1	15	15
12 J	8.5.7.1	12	28
	9.4.3.2	5	
	9.9.4.4	11	
13 B	7.2.1.1	6	24
	9.9.3.2	11	
	9.8.3.2	7	
14 H	2.2.3.2	24	24
Total K = 282			

Pilot
A/C

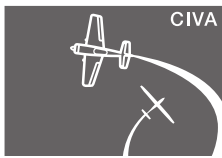

FAI
AEROBATICS
COMMISSION

EAAC 2019 1st - 10th August

Form B

Pilot ID

CIVA Advanced Unknown1

Flight #

RUS

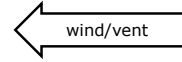

H

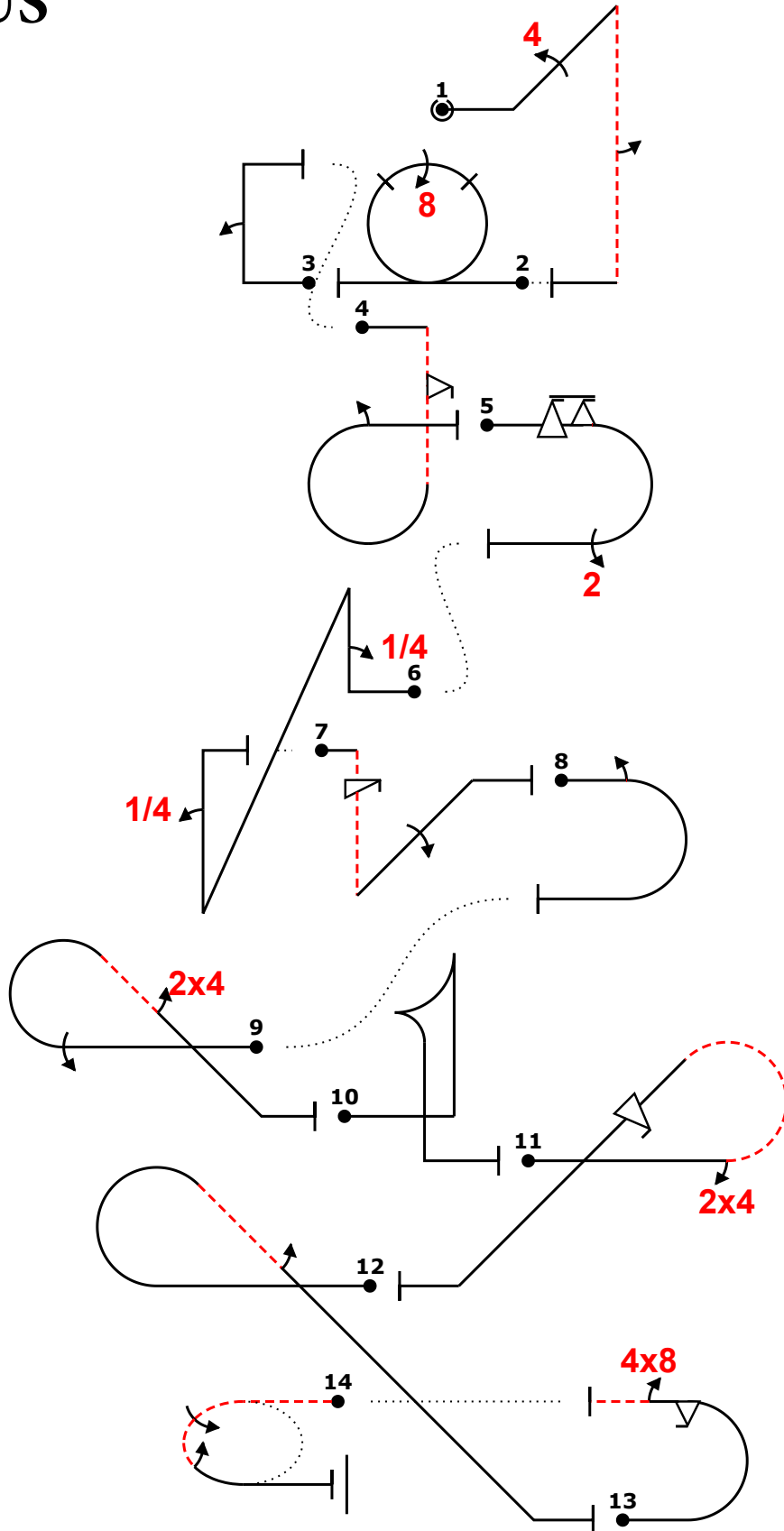

Power			
Fig	Aresti	K	
1 G	1.2.1.1	13	30
	9.4.2.4	13	
	9.1.5.2	4	
2 C	7.4.1.1	10	25
	9.8.3.4	15	
3 Add.	1.1.6.1	10	6
	9.1.1.2	8	
4 E	8.6.4.3	13	30
	9.9.10.2	13	
	9.1.3.2	4	
5 A	7.2.3.3	6	29
	9.9.3.6	14	
	9.2.3.4	9	
6 Add.	1.3.13.1	22	6
	9.1.1.1	6	
	9.1.1.1	6	
7 D	1.2.6.3	15	30
	9.11.1.4	5	
	9.1.2.4	10	
8 Add.	7.2.3.3	6	6
	9.1.3.2	4	
9 F	8.5.6.1	10	23
	9.1.3.4	8	
	9.4.4.2	5	
10 I	6.2.1.1	15	15
11 J	8.5.7.1	12	28
	9.4.3.2	5	
	9.9.4.4	11	
12 Add.	8.5.6.1	10	6
	9.1.4.2	4	
13 B	7.2.1.1	6	24
	9.9.3.2	11	
	9.8.3.2	7	
14 H	2.2.3.2	24	24
Total K = 282			

Pilot
A/C



EAAC 2019 1st - 10th August		Form B
Pilot ID	CIVA Advanced Unknown1	
		Flight #

LTU

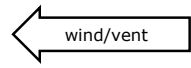

I

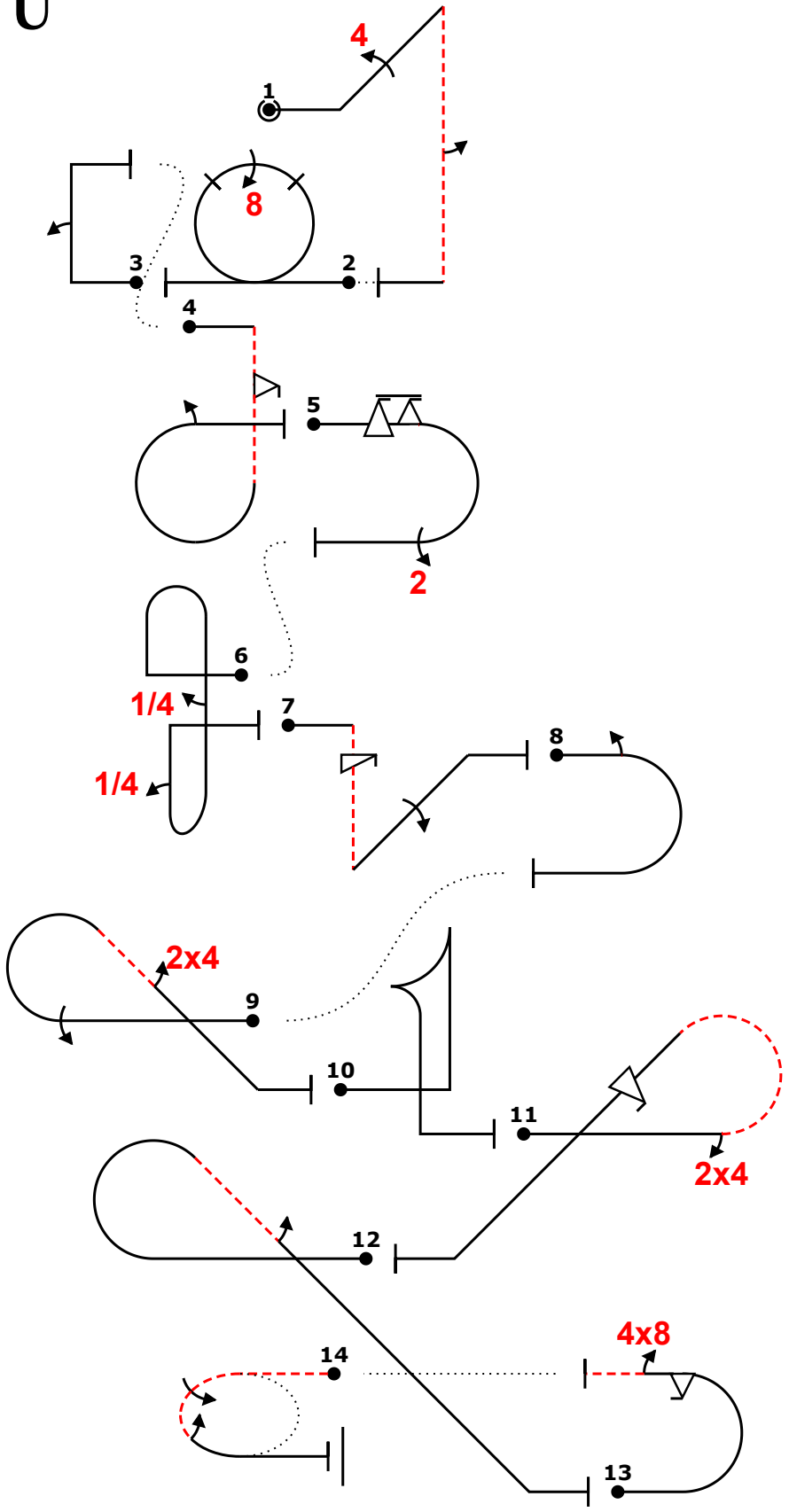

Power			
Fig	Aresti	K	
1 G	1.2.1.1	13	30
	9.4.2.4	13	
	9.1.5.2	4	
2 C	7.4.1.1	10	25
	9.8.3.4	15	
3 Add.	1.1.6.1	10	6
	9.1.1.2	8	
4 E	8.6.4.3	13	30
	9.9.10.2	13	
	9.1.3.2	4	
5 A	7.2.3.3	6	29
	9.9.3.6	14	
	9.2.3.4	9	
6 Add.	8.8.2.1	19	6
	9.1.5.1	2	
	9.1.1.1	6	
7 D	1.2.6.3	15	30
	9.11.1.4	5	
	9.1.2.4	10	
8 Add.	7.2.3.3	6	6
	9.1.3.2	4	
9 F	8.5.6.1	10	23
	9.1.3.4	8	
	9.4.4.2	5	
10 I	6.2.1.1	15	15
11 J	8.5.7.1	12	28
	9.4.3.2	5	
	9.9.4.4	11	
12 Add.	8.5.6.1	10	6
	9.1.4.2	4	
13 B	7.2.1.1	6	24
	9.9.3.2	11	
	9.8.3.2	7	
14 H	2.2.3.2	24	24
Total K = 282			

_____ Pilot
 A/C

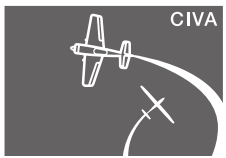

FAI
AEROBATICS
COMMISSION

GER

EAAC 2019 1st - 10th August

Form B

Pilot ID

CIVA Advanced Unknown1

Flight #

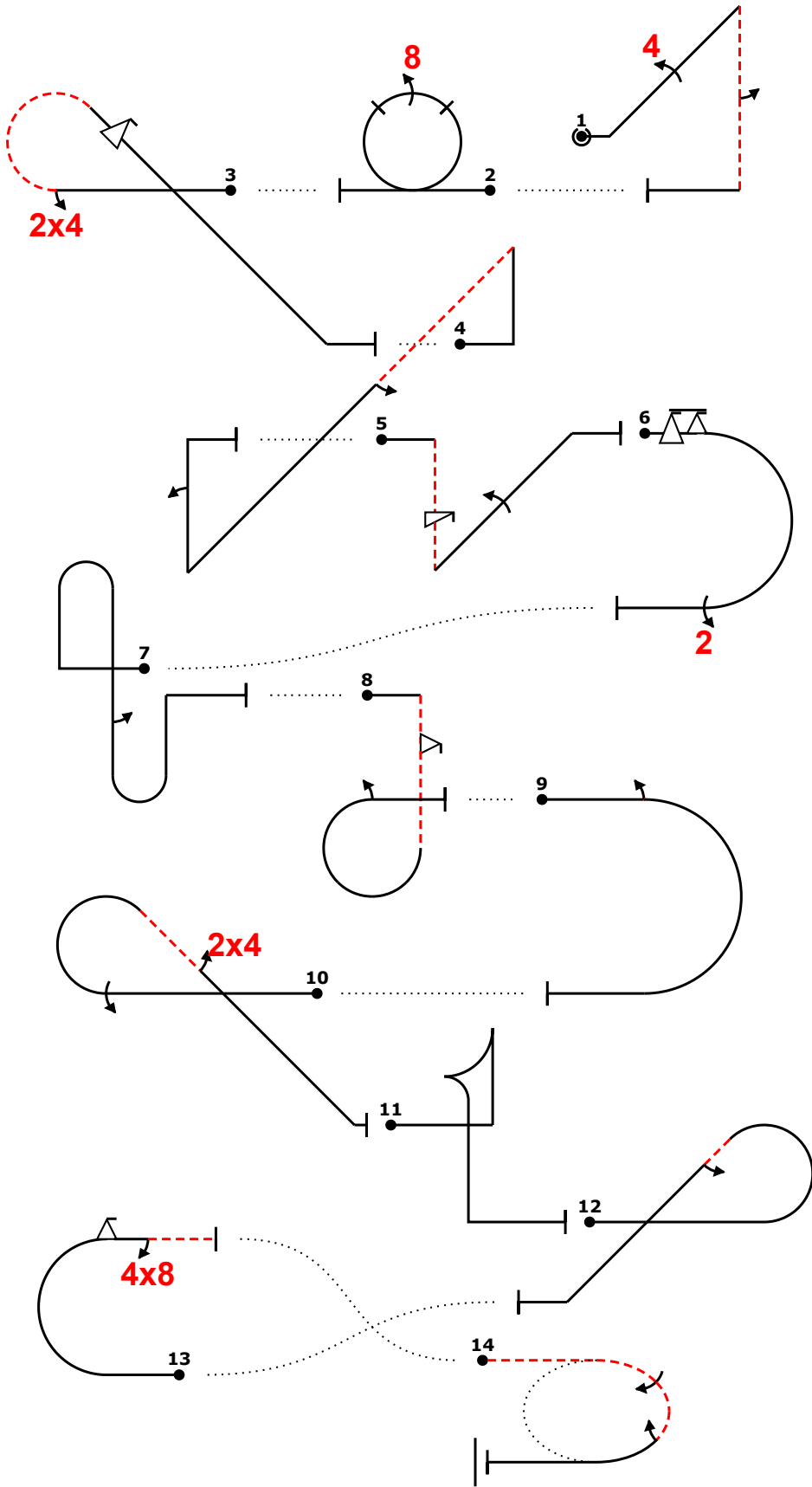
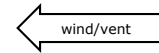

Power			
Fig	Aresti	K	
1 G	1.2.1.1	13	30
	9.4.2.4	13	
	9.1.5.2	4	
2 C	7.4.1.1	10	25
	9.8.3.4	15	
3 J	8.5.7.1	12	28
	9.4.3.2	5	
	9.9.4.4	11	
4 Add.	1.3.12.1	21	6
	9.1.4.2	4	
	9.1.1.2	8	
5 D	1.2.6.3	15	30
	9.11.1.4	5	
	9.1.2.4	10	
6 A	7.2.3.3	6	29
	9.9.3.6	14	
	9.2.3.4	9	
7 Add.	8.8.2.1	19	6
	9.1.5.2	4	
8 E	8.6.4.3	13	30
	9.9.10.2	13	
	9.1.3.2	4	
9 Add.	7.2.3.3	6	6
	9.1.3.2	4	
10 F	8.5.6.1	10	23
	9.1.3.4	8	
	9.4.4.2	5	
11 I	6.2.1.1	15	15
12 Add.	8.5.6.1	10	6
	9.1.4.2	4	
13 B	7.2.1.1	6	24
	9.9.3.2	11	
	9.8.3.2	7	
14 H	2.2.3.2	24	24
Total K = 282			

Pilot
A/C



FAI
POL

K

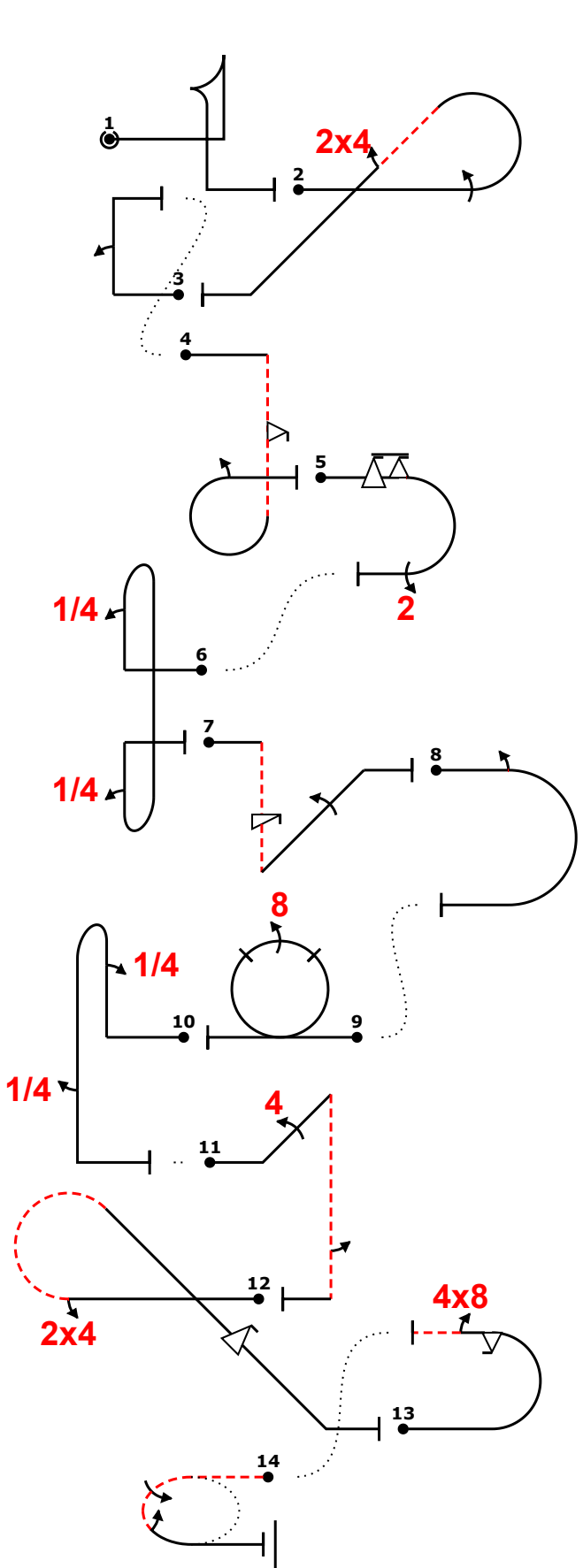

Power			
Fig	Aresti	K	
1	6.2.1.1	15	15
2	8.5.6.1	10	23
	9.1.3.4	8	
	9.4.4.2	5	
3	1.1.6.1	10	6
	9.1.1.2	8	
4	8.6.4.3	13	30
	9.9.10.2	13	
	9.1.3.2	4	
5	7.2.3.3	6	29
	9.9.3.6	14	
	9.2.3.4	9	
6	8.8.2.1	19	6
	9.1.1.1	6	
	9.1.1.1	6	
7	1.2.6.3	15	30
	9.11.1.4	5	
	9.1.2.4	10	
8	7.2.3.3	6	6
	9.1.3.2	4	
9	7.4.1.1	10	25
	9.8.3.4	15	
10	8.4.1.1	13	6
	9.1.1.1	6	
	9.1.5.1	2	
11	1.2.1.1	13	30
	9.4.2.4	13	
	9.1.5.2	4	
12	8.5.7.1	12	28
	9.4.3.2	5	
	9.9.4.4	11	
13	7.2.1.1	6	24
	9.9.3.2	11	
	9.8.3.2	7	
14	2.2.3.2	24	24
Total K = 282			

Pilot

A/C

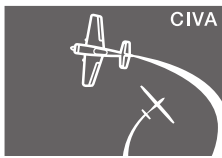

FAI
AEROBATICS
COMMISSION
GER

EAAC 2019 1st - 10th August		Form B
Pilot ID	CIVA Advanced Unknown1	Flight #

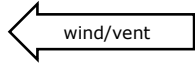

L

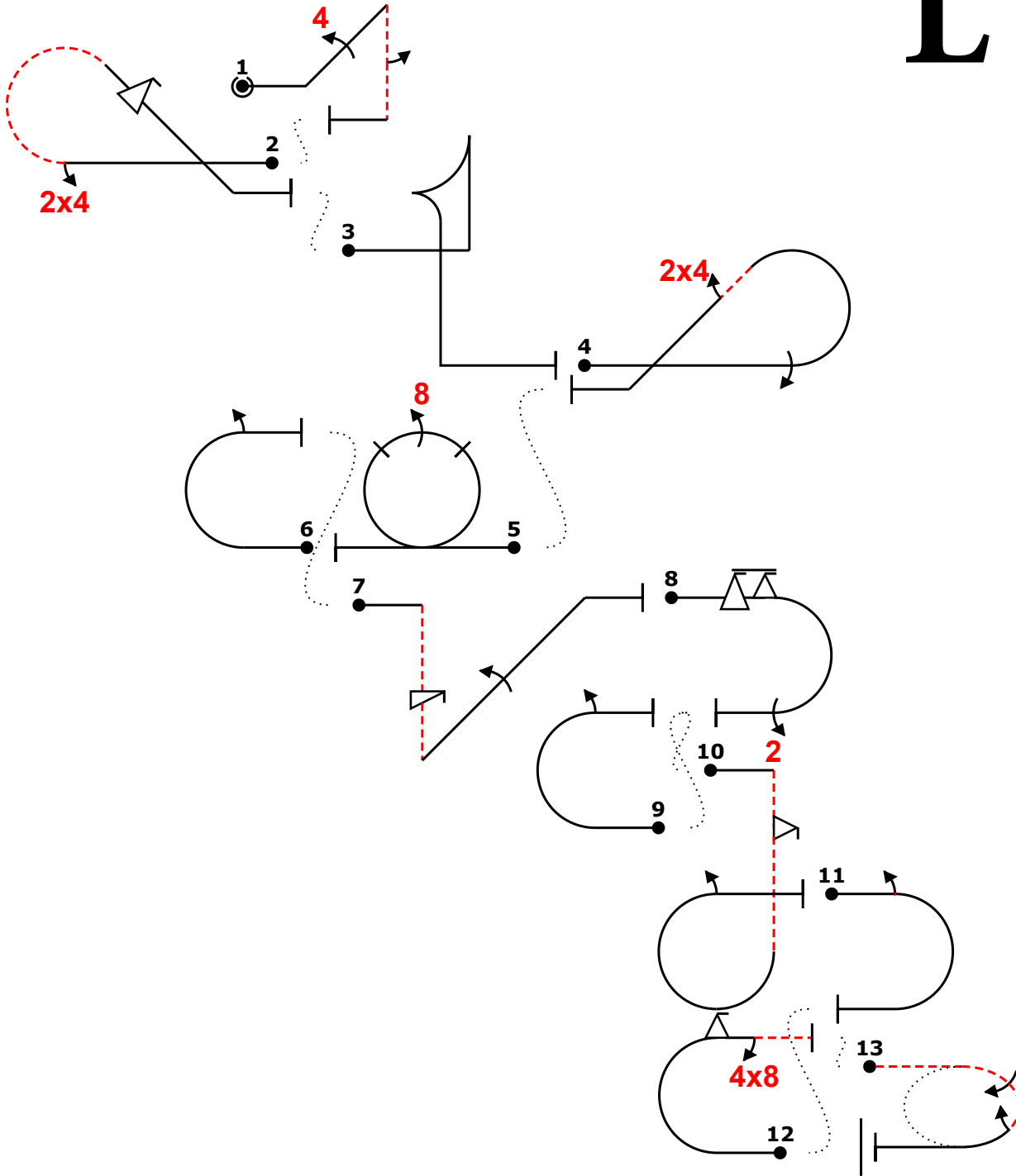

Power			
Fig	Aresti	K	
1 G	1.2.1.1	13	30
	9.4.2.4	13	
	9.1.5.2	4	
2 J	8.5.7.1	12	28
	9.4.3.2	5	
	9.9.4.4	11	
3 I	6.2.1.1	15	15
4 F	8.5.6.1	10	23
	9.1.3.4	8	
	9.4.4.2	5	
5 C	7.4.1.1	10	25
9.8.3.4	15		
6 Add.	7.2.2.1	6	8
	9.1.3.2	4	
7 D	1.2.6.3	15	30
	9.11.1.4	5	
	9.1.2.4	10	
8 A	7.2.3.3	6	29
	9.9.3.6	14	
	9.2.3.4	9	
9 Add.	7.2.2.1	6	8
	9.1.3.2	4	
10 E	8.6.4.3	13	30
	9.9.10.2	13	
	9.1.3.2	4	
11 Add.	7.2.3.3	6	8
	9.1.3.2	4	
12 B	7.2.1.1	6	24
	9.9.3.2	11	
	9.8.3.2	7	
13 H	2.2.3.2	24	24
Total K = 282			

Pilot

A/C

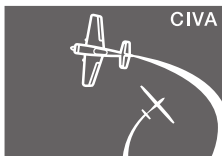

CIVA

FAI

AEROBATICS COMMISSION

FRA

EAAC 2019 1st - 10th August

Form B

Pilot ID

CIVA Advanced Unknown1

Flight #

wind/vent

M

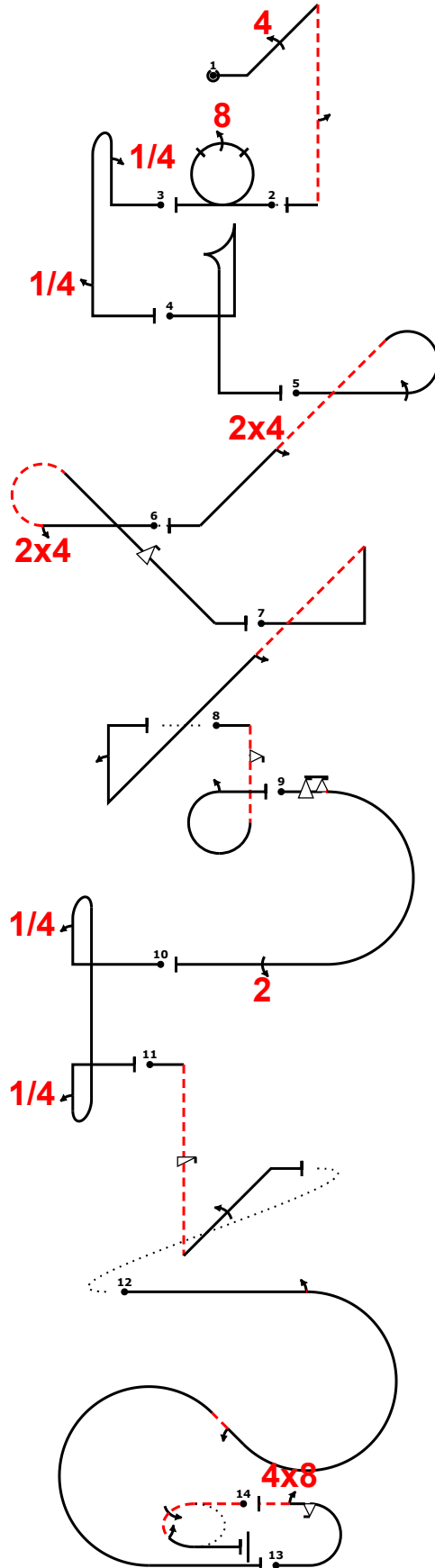

Fig	Aresti	K
1	G 1.2.1.1	13
	9.4.2.4	30
	9.1.5.2	4
2	7.4.1.1	10
	C 9.8.3.4	15
		25
3	8.4.1.1	13
	Add. 9.1.1.1	6
	9.1.5.1	2
4	I 6.2.1.1	15
5	8.5.6.1	10
	F 9.1.3.4	8
	9.4.4.2	23
6	8.5.7.1	12
	J 9.4.3.2	5
	9.9.4.4	28
7	1.3.12.1	21
	Add. 9.1.4.2	4
	9.1.1.2	8
8	E 8.6.4.3	13
	9.9.10.2	13
	9.1.3.2	30
9	A 7.2.3.3	6
	9.3.3.6	14
	9.2.3.4	29
10	Add. 8.8.2.1	19
	9.1.1.1	6
	9.1.1.1	6
11	D 1.2.6.3	15
	9.1.1.4	5
	9.1.2.4	30
12	7.5.5.3	15
	Add. 9.1.3.2	4
	9.1.2.2	6
13	B 7.2.1.1	6
	9.9.3.2	11
	9.8.3.2	24
14	H 2.2.3.2	24
		24
		24
Total K = 282		

 Pilot
 A/C



FAI
POL

AEROBATICS
COMMISSION

EAAC 2019 1st - 10th August

Form B

Pilot ID

CIVA Advanced Unknown1

Flight #

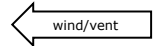

N

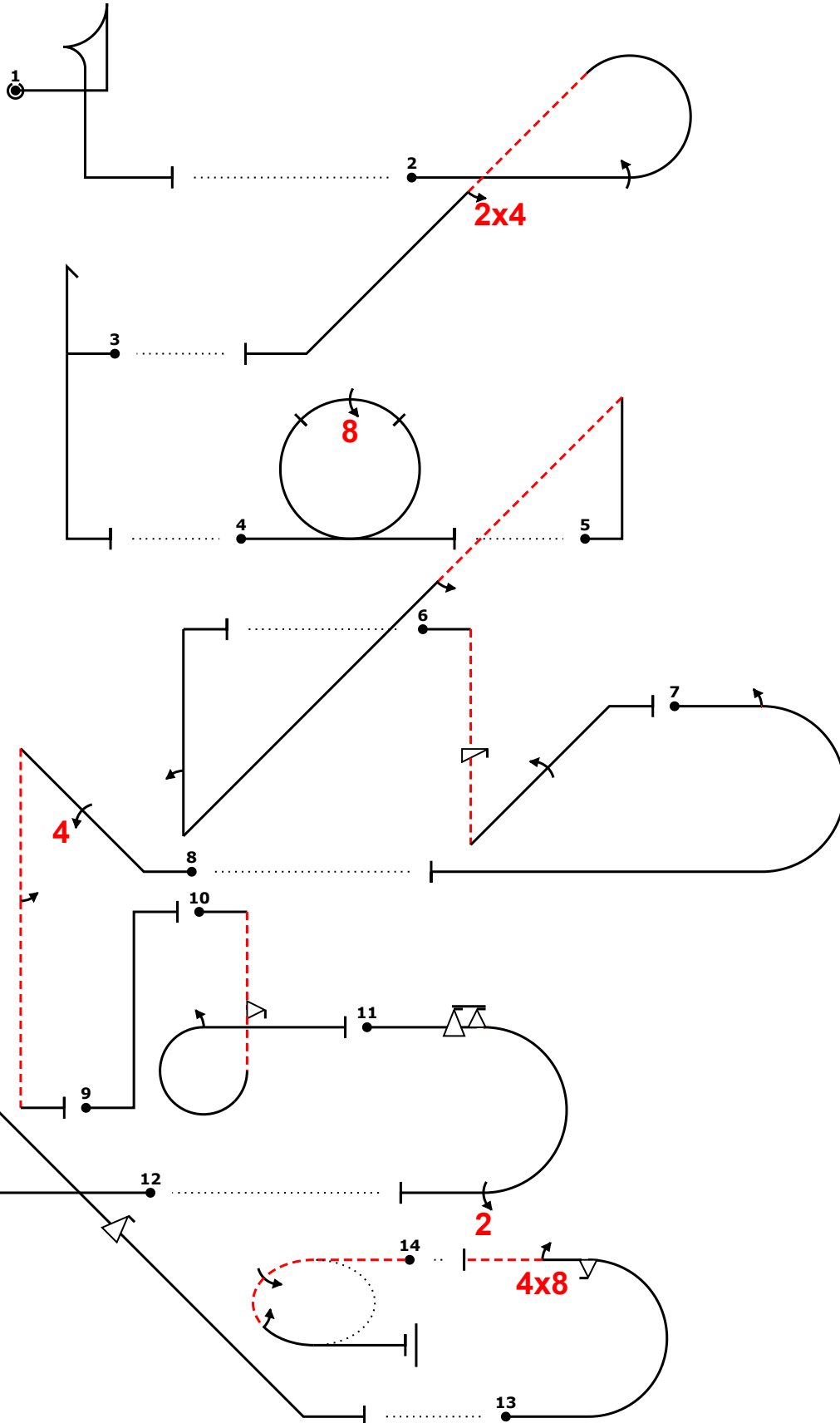

Power			
Fig	Aresti	K	
1	6.2.1.1	15	15
2	8.5.6.1	10	23
	9.1.3.4	8	
	9.4.4.2	5	
3	5.2.1.1	17	6
4	7.4.1.1	10	25
	9.8.3.4	15	
5	1.3.12.1	21	6
	9.1.4.2	4	
	9.1.1.2	8	
6	1.2.6.3	15	30
	9.11.1.4	5	
	9.1.2.4	10	
7	7.2.3.3	6	6
	9.1.3.2	4	
8	1.2.1.1	13	30
	9.4.2.4	13	
	9.1.5.2	4	
9	1.1.6.1	10	6
10	8.6.4.3	13	30
	9.9.10.2	13	
	9.1.3.2	4	
11	7.2.3.3	6	29
	9.9.3.6	14	
	9.2.3.4	9	
12	8.5.7.1	12	28
	9.4.3.2	5	
	9.9.4.4	11	
13	7.2.1.1	6	24
	9.9.3.2	11	
	9.8.3.2	7	
14	2.2.3.2	24	24
Total K = 282			

Pilot
A/C