

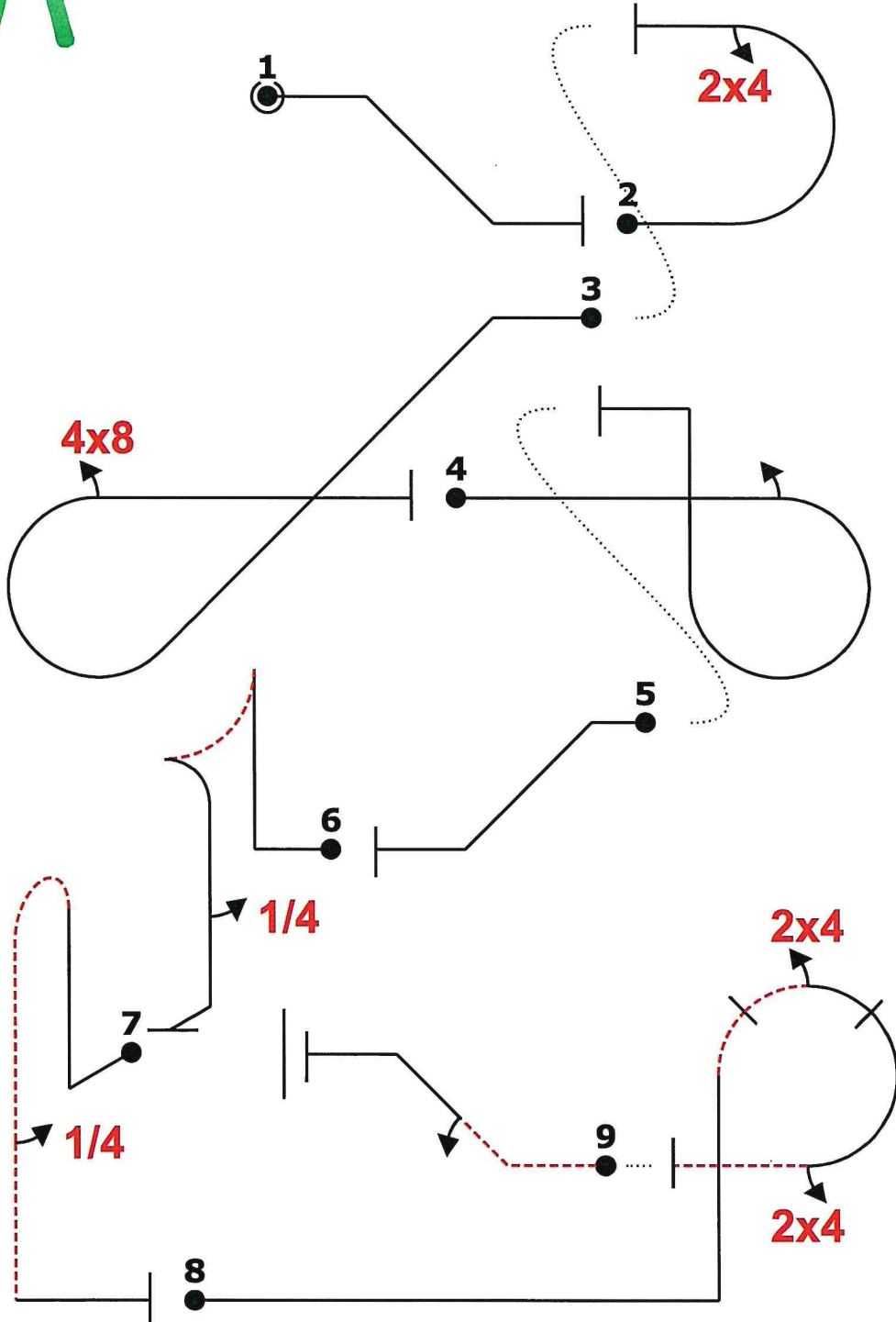

LRDV 18 maja 2019		Seq. A	Form B
Pilot ID	CIVA Glider Advanced FreeUnknown		Flight #

**A**



Glider			
Fig	Aresti	K	
1	1.1.2.3	7	5
<b>Add.</b>			
2	7.2.2.1	6	14
F	9.4.3.2	8	
3	8.5.3.3	10	21
E	9.8.3.2	11	
4	8.6.8.3	12	18
C	9.1.3.2	6	
5	1.1.2.3	7	5
<b>Add.</b>			
6	6.2.2.1	17	20
G	9.1.5.1	3	
7	8.4.3.1	15	18
D	9.1.5.1	3	
8	8.6.20.1	13	29
A	9.4.3.2	8	
	9.4.3.2	8	
9	1.1.3.2	8	17
B	9.1.2.2	9	
<b>Total K = 147</b>			
(max K = 160)			

"0L" id "0E" 1 1/2 m24 (2,13) "0E" ..'irc48 "0C" ..2ip'' (6,14) "0L" ''+id "0C" ''''+ita''4''+'''' "0D" ''+pb.4. "0A" -+++++xp(24)24- (1,0) "0B" -d'2

Pacak Pilot  
Swift SP-3529  
A/C



LRDV 18 maja 2019		Seq. B	Form B
Pilot ID	CIVA Glider Advanced FreeUnknown		Flight #

B

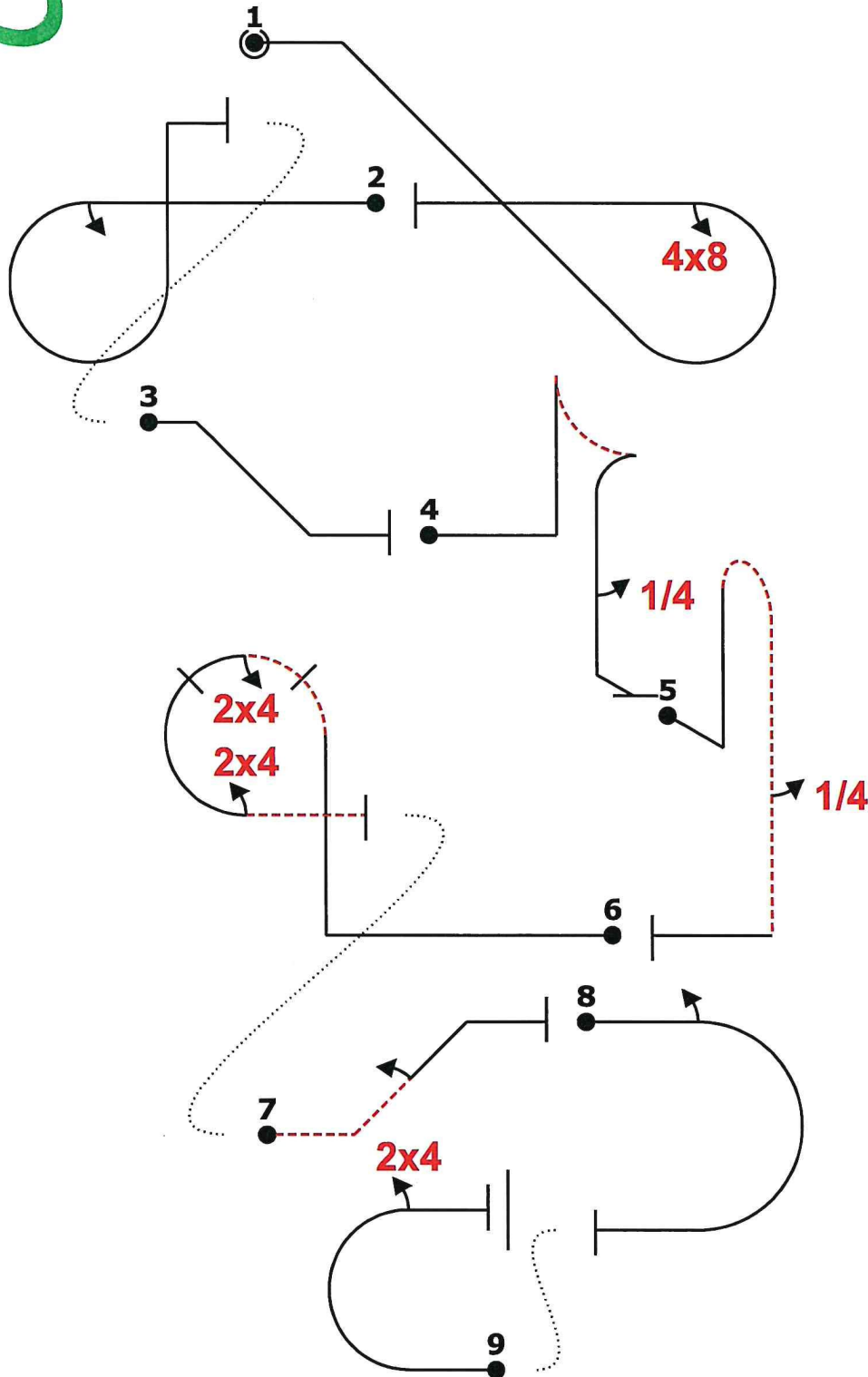

Glider			
Fig	Aresti	K	
1	8.5.3.3	10	21
	E 9.8.3.2	11	
2	8.6.8.3	12	18
	C 9.1.3.2	6	
3	1.1.2.3	7	5
4	6.2.2.1	17	20
	G 9.1.5.1	3	
5	8.4.3.1	15	18
	D 9.1.5.1	3	
6	8.6.20.1	13	29
	A 9.4.3.2	8	
	9.4.3.2	8	
7	1.1.3.2	8	17
	B 9.1.2.2	9	
8	7.2.3.3	6	5
	Add. 9.1.3.2	6	
9	7.2.2.1	6	14
	F 9.4.3.2	8	
<b>Total K = 147</b>			
(max K = 160)			

"EE" /.. 'irc48 "EC" ..2ip''+` (-8,15) "EL" ""+id "EG" ""+ita''4''+"" ""ED" ""+pb.4. "EA" ~++z(24)24- (-9,16) "EB" -d2 3% "EL  
" 2a (-1,7) "EE" m24

Cichon Pilot  
Swift SP-3529  
A/C



Seq. C		Form B
Pilot ID	CIVA Glider Advanced FreeUnknown	Flight #

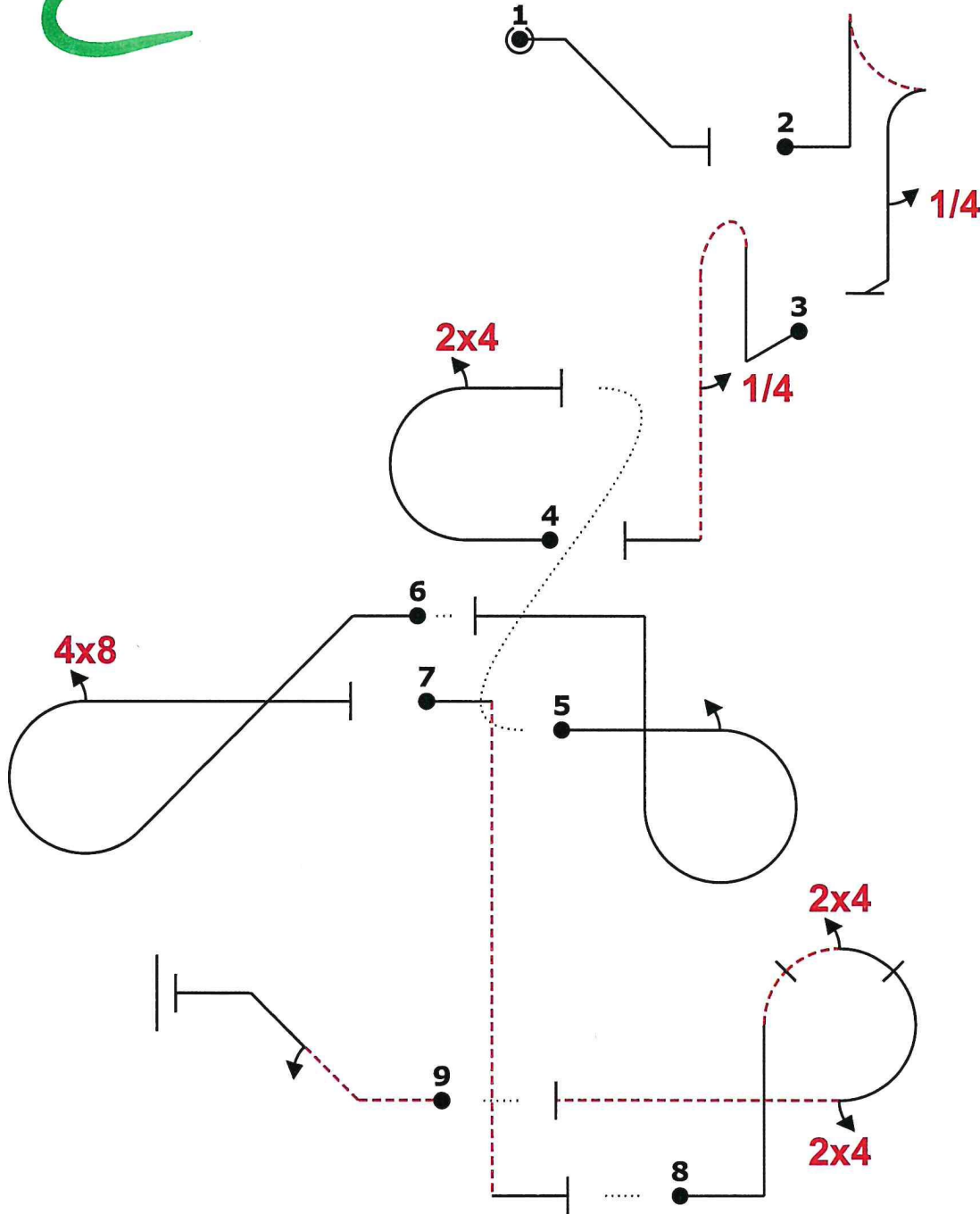
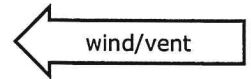

Glider			
Fig	Aresti	K	
1	1.1.2.3	7	5
<b>Add.</b>			
2	6.2.2.1 G 9.1.5.1	17 3	20
3	8.4.3.1 D 9.1.5.1	15 3	18
4	7.2.2.1 F 9.4.3.2	6 8	14
5	8.6.8.3 9.1.3.2	12 6	18
6	8.5.3.3 E 9.8.3.2	10 11	21
<b>Add.</b>			
7	1.1.6.3	10	5
8	8.6.20.1 A 9.4.3.2 9.4.3.2	13 8 8	29
9	1.1.3.2 B 9.1.2.2	8 9	17
Total K = 147		(max K = 160)	

"0L" ""id+"" (0,0) "0G" "" ""ita"" ""4"" "" "" "" [0,0] "0D" "" "" ""pb4."" "" (0,0) "0F" m24- (-4,18) 2ip+~ [1,0] "0E" "" ""irc48 (0,0) "0L" ""iv..... (2,0) "0A" ""rp(24)24---- (-2,0) "0B" -d2

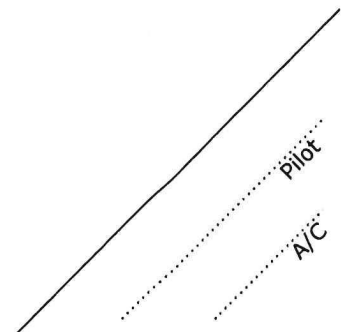

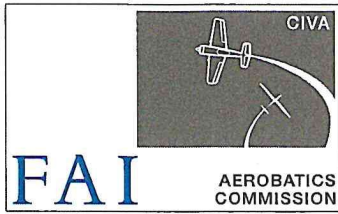

Seq. D		Form B
Pilot ID	Glider	Flight #

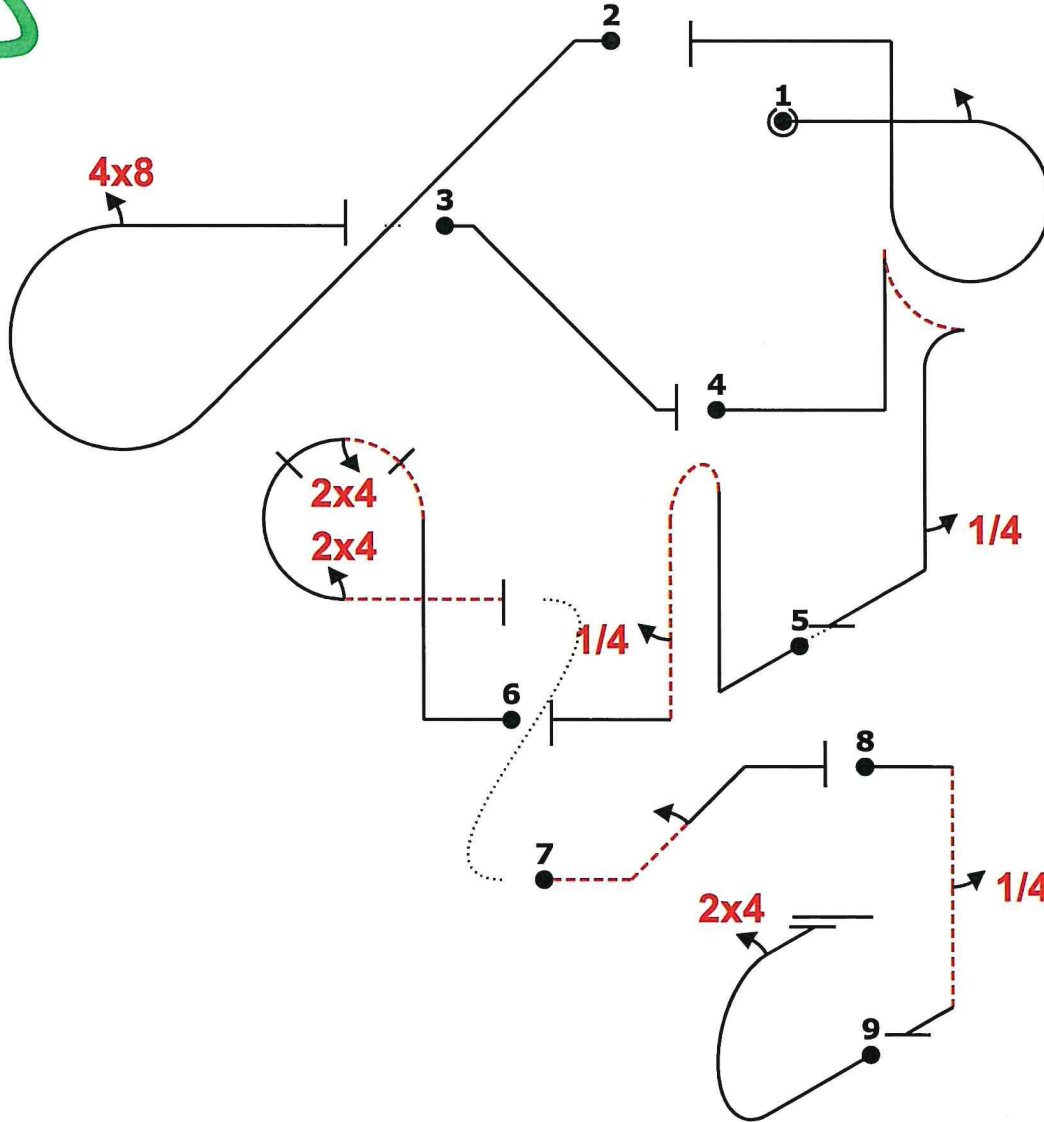

Glider			
Fig	Aresti	K	
1	8.6.8.3	12	18
C	9.1.3.2	6	
2	8.5.3.3	10	21
E	9.8.3.2	11	
3	1.1.2.3	7	5
<b>Add.</b>			
4	6.2.2.1	17	20
G	9.1.5.1	3	
5	8.4.3.1	15	18
D	9.1.5.1	3	
6	8.6.20.1	13	29
A	9.4.3.2	8	
	9.4.3.2	8	
7	1.1.3.2	8	17
B	9.1.2.2	9	
8	1.1.6.3	10	5
<b>Add.</b>	9.1.5.1	3	
9	7.2.2.1	6	14
F	9.4.3.2	8	
Total K = 147			

"@C" '2ip'++ (0,0) "@E" 4% 'irc48+'''''' (1,0) "@L" '''+id.'''+' "@G" ita4 (2,-1) "@D" ' 'pb,4 "EA" xp(24)24--- (-2,14) "@B" -d2 "@L" iv''4'' "@F" ~-''m24

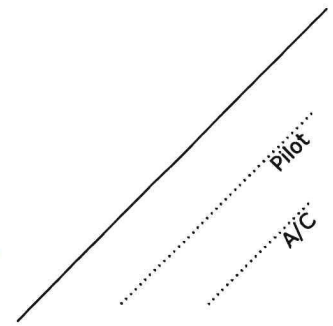



<b>Seq. U</b>		Form B
Pilot ID	CIVA Glider Advanced FreeUnknown	Flight #

E

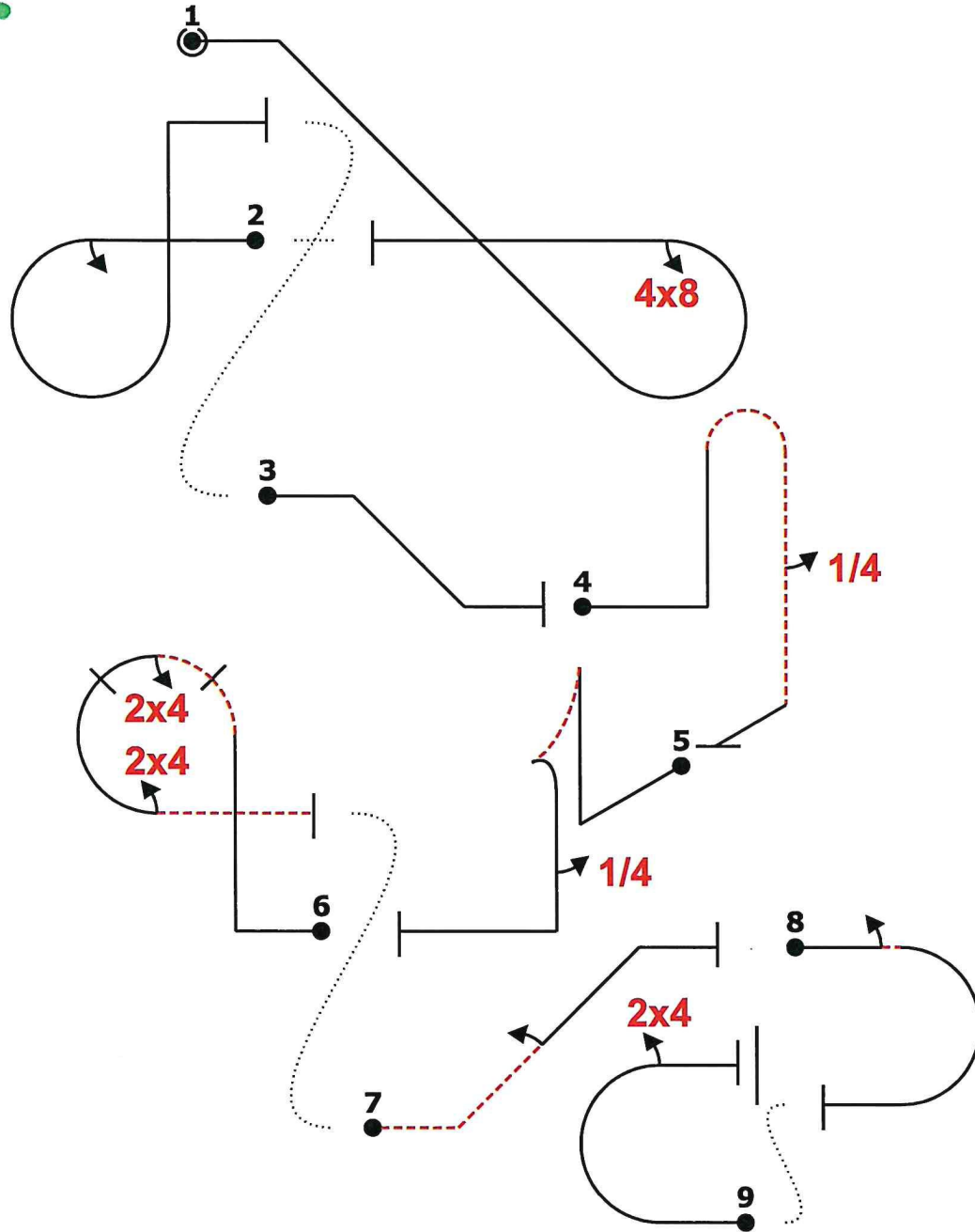

Glider			
Fig	Aresti	K	
1	8.5.3.3	10	21
	E 9.8.3.2	11	
2	8.6.8.3	12	18
	C 9.1.3.2	6	
3	1.1.2.3	7	5
4	8.4.3.1	15	18
	D 9.1.5.1	3	
5	6.2.2.1	17	20
	G 9.1.5.1	3	
6	8.6.20.1	13	29
	A 9.4.3.2	8	
	9.4.3.2	8	
7	1.1.3.2	8	17
	B 9.1.2.2	9	
8	7.2.3.3	6	5
	Add. 9.1.3.2	6	
9	7.2.2.1	6	14
	F 9.4.3.2	8	
<b>Total K = 147</b> (max K = 160)			

"0E" ...'irc48~ (-2,0) "0C" 2ip~ (-4,19) "0L" id "0D" pb4. "0G" ita''''4' (0,0) "0A" rp(24)24--- (-1,16) "0B" -d''2. (0,0) "0L" 2' a (0,6) "0E" m24

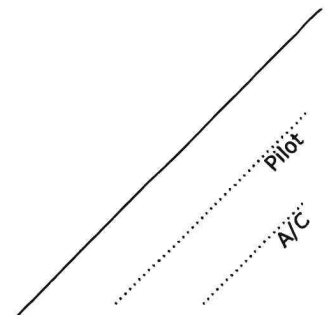

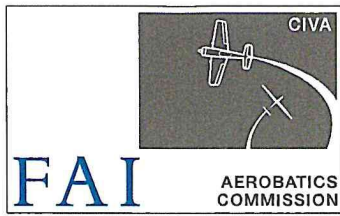

Seq. F		Form B
Pilot ID	CIVA Glider Advanced FreeUnknown	Flight #

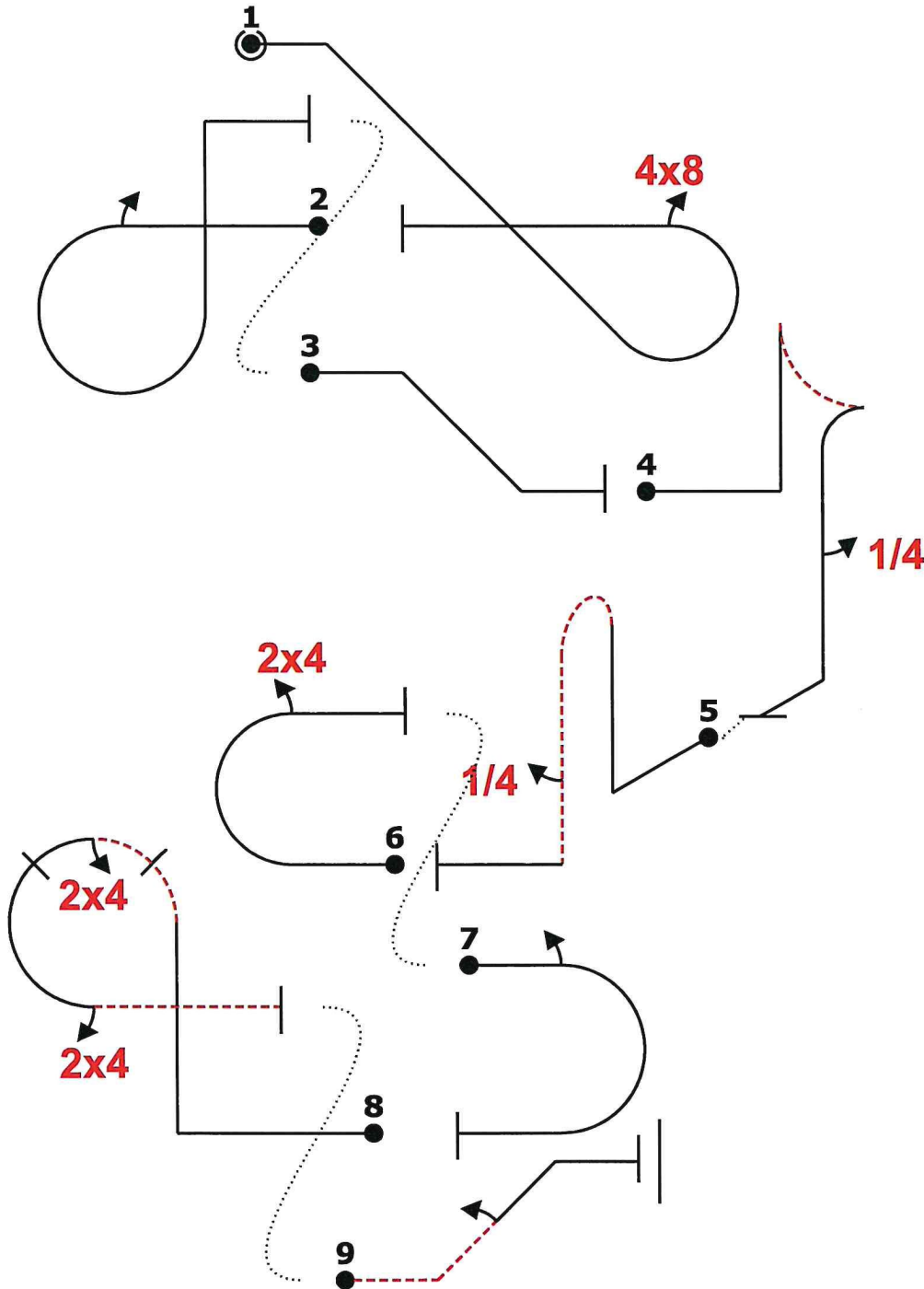

Glider			
Fig	Aresti	K	
1	8.5.3.3	10	21
	E 9.8.3.2	11	
2	8.6.8.3	12	18
	C 9.1.3.2	6	
3	1.1.2.3	7	5
4	6.2.2.1	17	20
	G 9.1.5.1	3	
5	8.4.3.1	15	18
	D 9.1.5.1	3	
6	7.2.2.1	6	14
	F 9.4.3.2	8	
7	7.2.3.3	6	5
	Add. 9.1.3.2	6	
8	8.6.20.1	13	29
	A 9.4.3.2	8	
	9.4.3.2	8	
9	1.1.3.2	8	17
	B 9.1.2.2	9	
<b>Total K = 147</b> (max K = 160)			

-2% "0E" ... 'irc,48-- (0,0) "0C" ',2ip~- (-4,12) "0L" id "0G" ''ita''4.'+''' (1,-1) "0D" -pb,4 -1% "0E" 'm24-- (-1,12) "0L" 2a- (0,0) "0A" --+rp(24),24-- (-1,13) "0B" -d2

Lariomov O Pilot  
 S-1 RA 0418a  
 A/C

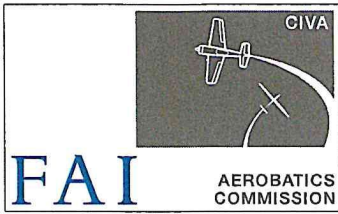

Seq. G		Form B
Pilot ID	CIVA Glider Advanced FreeUnknown	Flight #

G

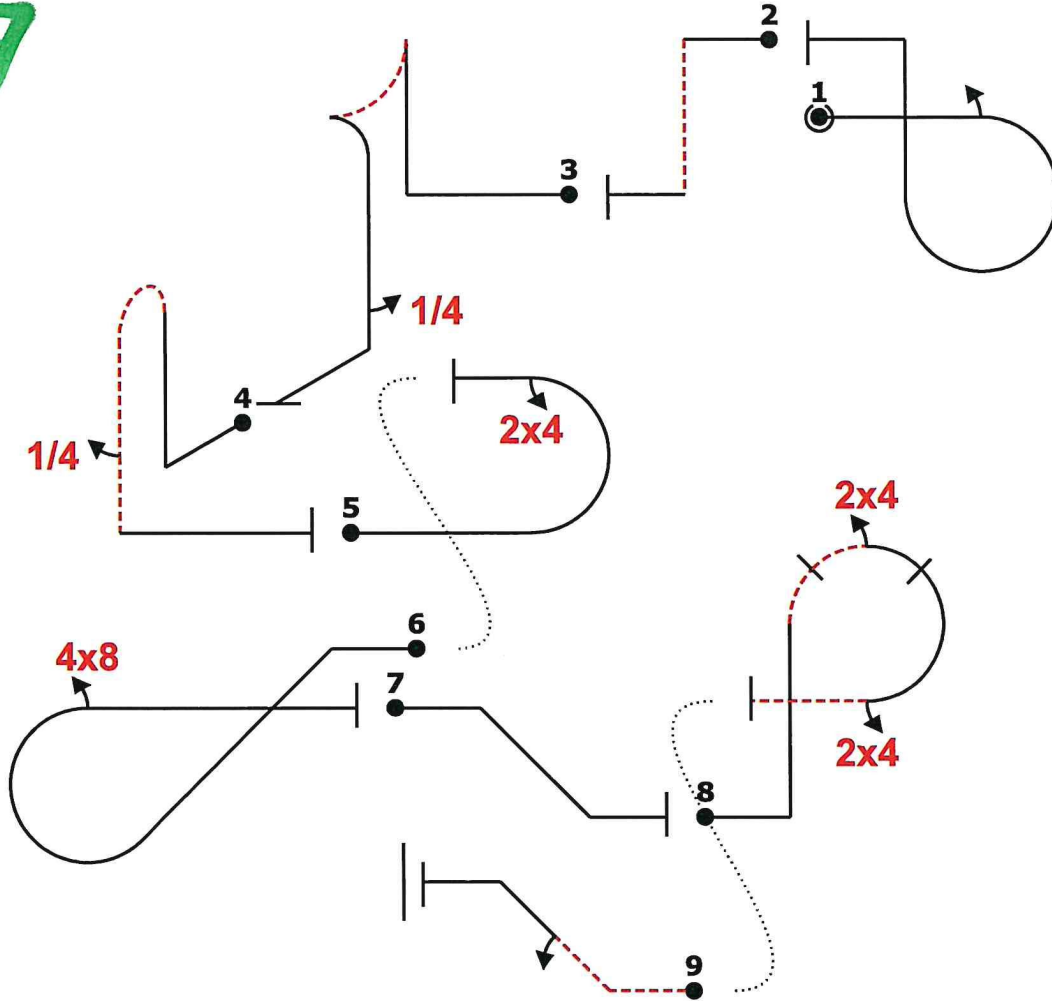

Glider		
Fig	Aresti	K
1	8.6.8.3	12
C	9.1.3.2	6
		18
2	1.1.6.3	10
Add.		5
3	6.2.2.1	17
G	9.1.5.1	3
		20
4	8.4.3.1	15
D	9.1.5.1	3
		18
5	7.2.2.1	6
F	9.4.3.2	8
		14
6	8.5.3.3	10
E	9.8.3.2	11
		21
7	1.1.2.3	7
Add.		5
8	8.6.20.1	13
A	9.4.3.2	8
	9.4.3.2	8
		29
9	1.1.3.2	8
B	9.1.2.2	9
		17
<b>Total K = 147</b>		
(max K = 160)		

"ec" 2ip`~ "el" iv "eg" ita4 "ed" pb,4~ "ef" .''m24 (2,14) "ee" irc48 "el" id "ea" xp(24)24- (1,15) "eb" -d2

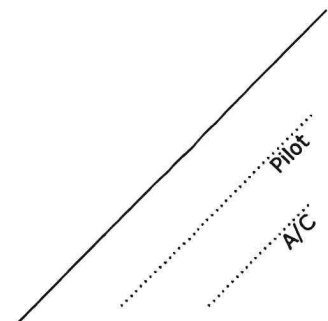

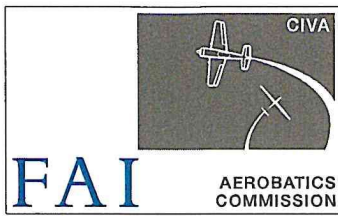

Seq. H		Form B
Pilot ID	CIVA Glider Advanced FreeUnknown	Flight #

H

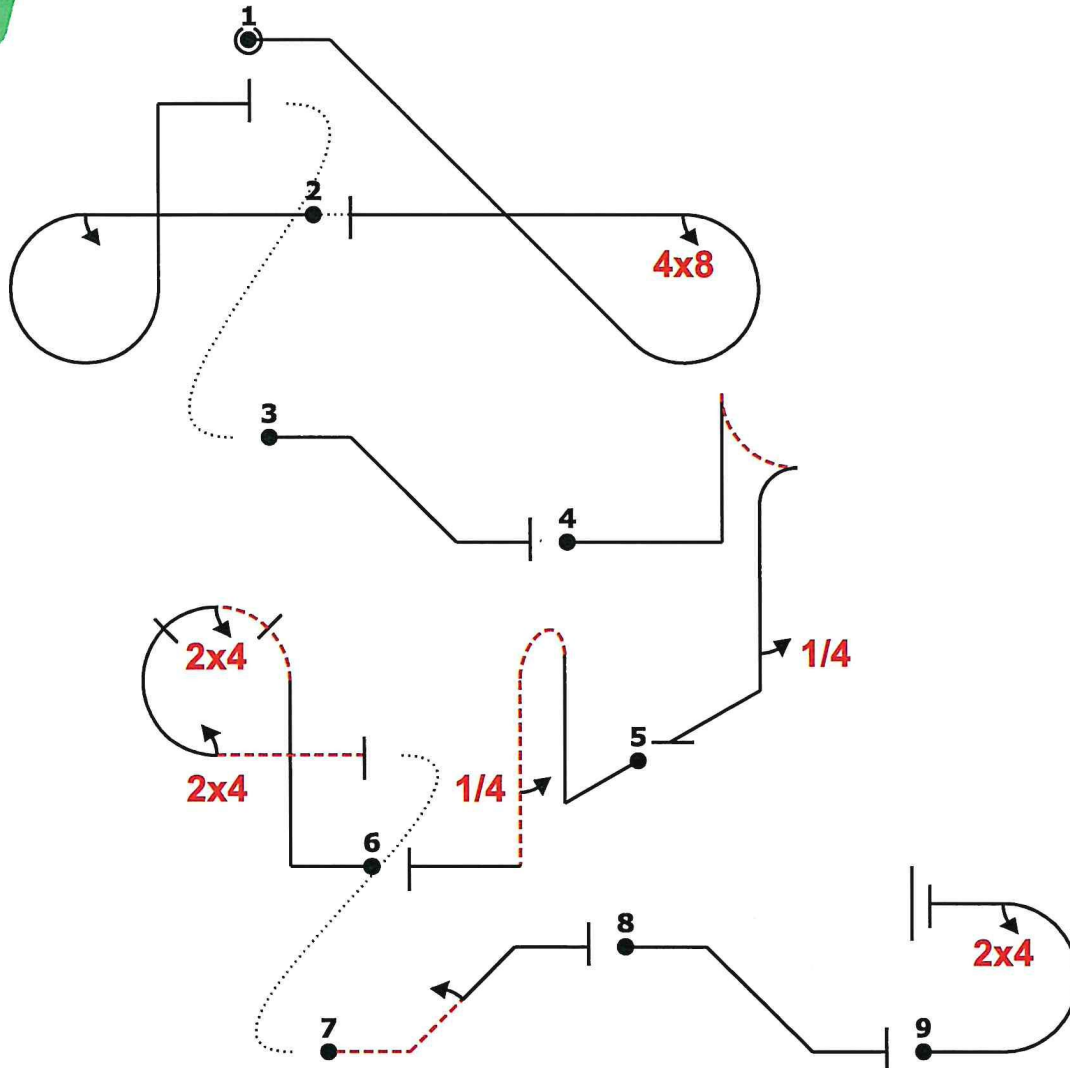
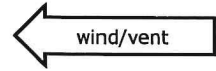

Glider			
Fig	Aresti	K	
1	8.5.3.3	10	21
E	9.8.3.2	11	
2	8.6.8.3	12	18
C	9.1.3.2	6	
3	1.1.2.3	7	5
<b>Add.</b>			
4	6.2.2.1	17	20
G	9.1.5.1	3	
5	8.4.3.1	15	18
D	9.1.5.1	3	
6	8.6.20.1	13	29
A	9.4.3.2	8	
	9.4.3.2	8	
7	1.1.3.2	8	17
B	9.1.2.2	9	
8	1.1.2.3	7	5
<b>Add.</b>			
9	7.2.2.1	6	14
F	9.4.3.2	8	
<b>Total K = 147</b>			
(max K = 160)			

"0E" ...irc48+- (2,0) "0C" .:2ip- (-3,18) "0L" id "0G" ita4 "0D" pb"|"4 "0A" xp(24)"|"24--- (-6,16) "0B" -d2 "0L" id "0F" m24

All Pilot  
 MDM-1 Fox YR-1010  
 A/C



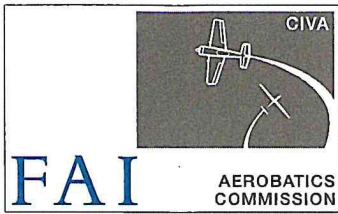

WAGAC Deva 2019      Seq. I		Form B
Pilot ID	CIVA Glider Advanced FreeUnknown	
	Flight #	

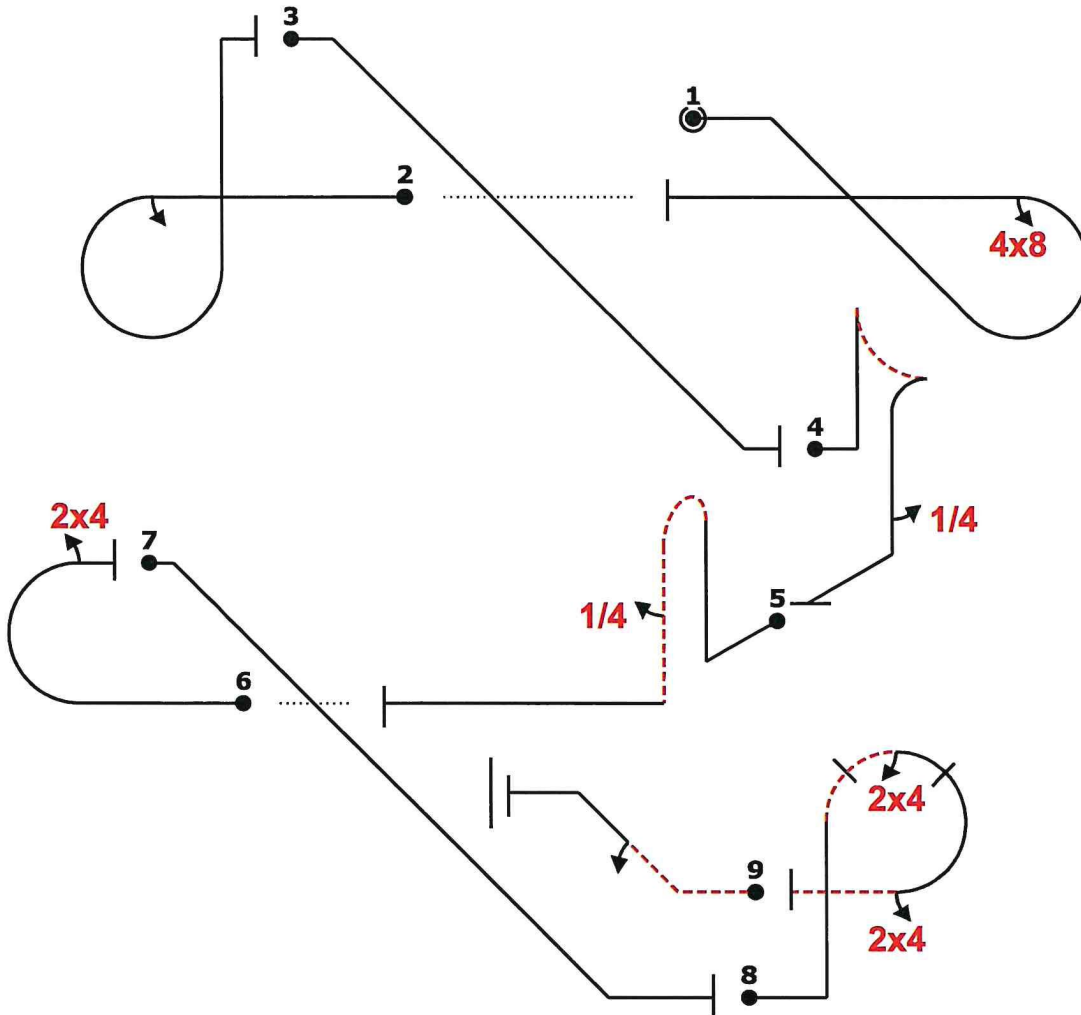

Glider			
Fig	Aresti	K	
1	8.5.3.3	10	21
	9.8.3.2	11	
2	8.6.8.3	12	18
	9.1.3.2	6	
3	1.1.2.3	7	5
4	6.2.2.1	17	20
	9.1.5.1	3	
5	8.4.3.1	15	18
	9.1.5.1	3	
6	7.2.2.1	6	14
	9.4.3.2	8	
7	1.1.2.3	7	5
8	8.6.20.1	13	29
	9.4.3.2	8	
	9.4.3.2	8	
9	1.1.3.2	8	17
	9.1.2.2	9	
<b>Total K = 147</b>		<b>(max K = 160)</b>	

"@E" "izc48++ [-11,0] "@C" ..2ip.+""@L" ""+id.....'+"" "@C" ""+ita""4 "@D" pb",4'+++~ (-4,0) "@F" .''m24+"" "@L" ""+id.....~ "@A" xp(,24)24- "@B" -d2

Lukas Martinec Pilot  
 MDM1 OK-7801 A/C

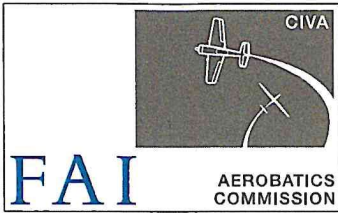

Seq. J		Form B
Pilot ID	CIVA Glider Advanced FreeUnknown	Flight #

J

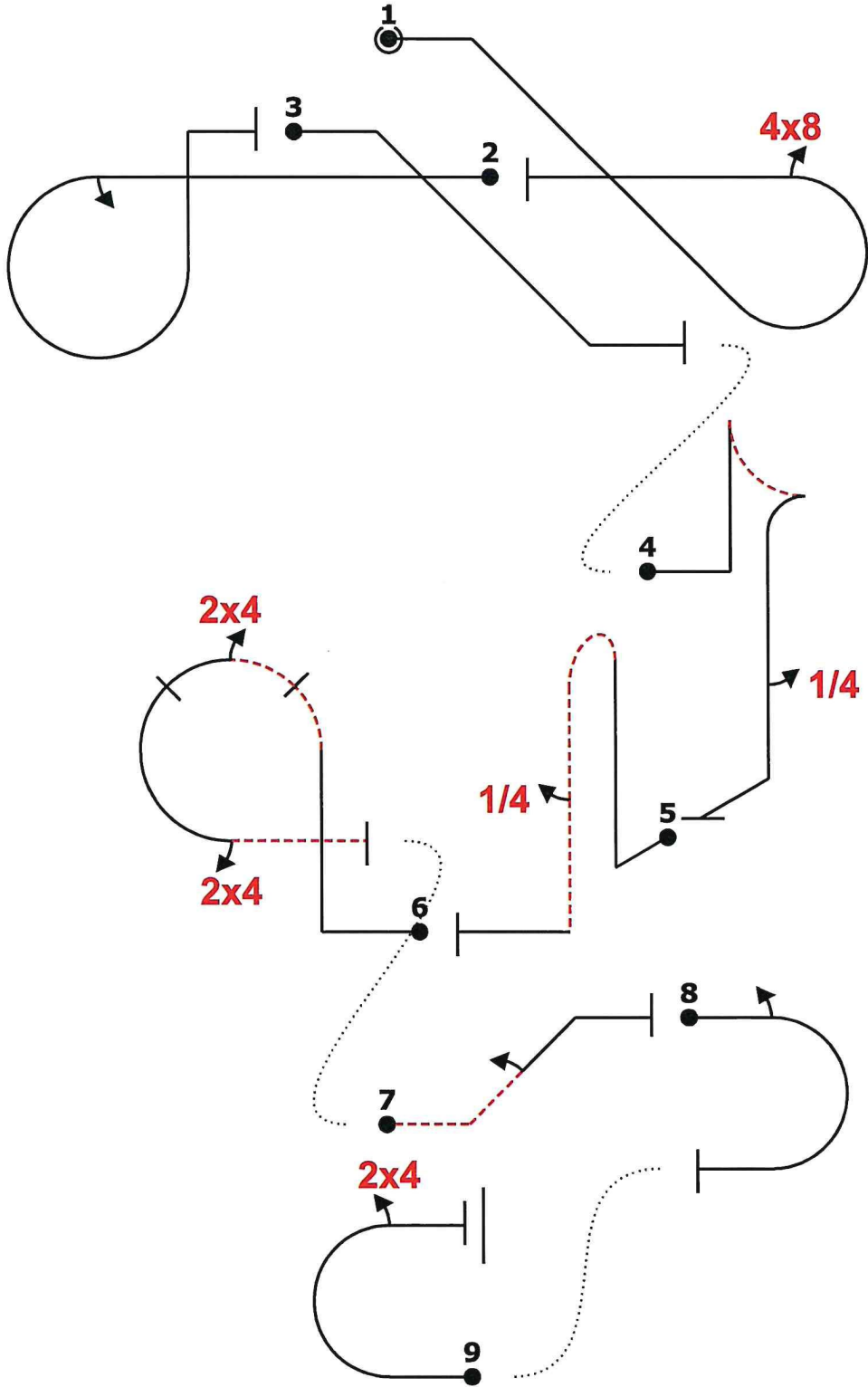

"@E" ..irc,48 "@C" 2% ...2ip"\*\*\*+ "l" id...'" "@G" (-6,12) \*\*\*\*\*+ita4.+\*\*\* "@D" \*\*\*+.pb,4. "@A" 2% \*\*\*rp(,24),24- "@B" (-3,15) -d2 "@L" 2a  
 "@F" (-8,11) m24

Team Austria  
 Swift and Fox  
 Pilot  
 A/C

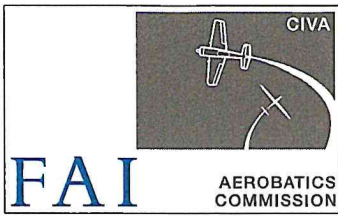

<b>Seq. K</b>		Form B
Pilot ID	CIVA Glider Advanced FreeUnknown	Flight #

K

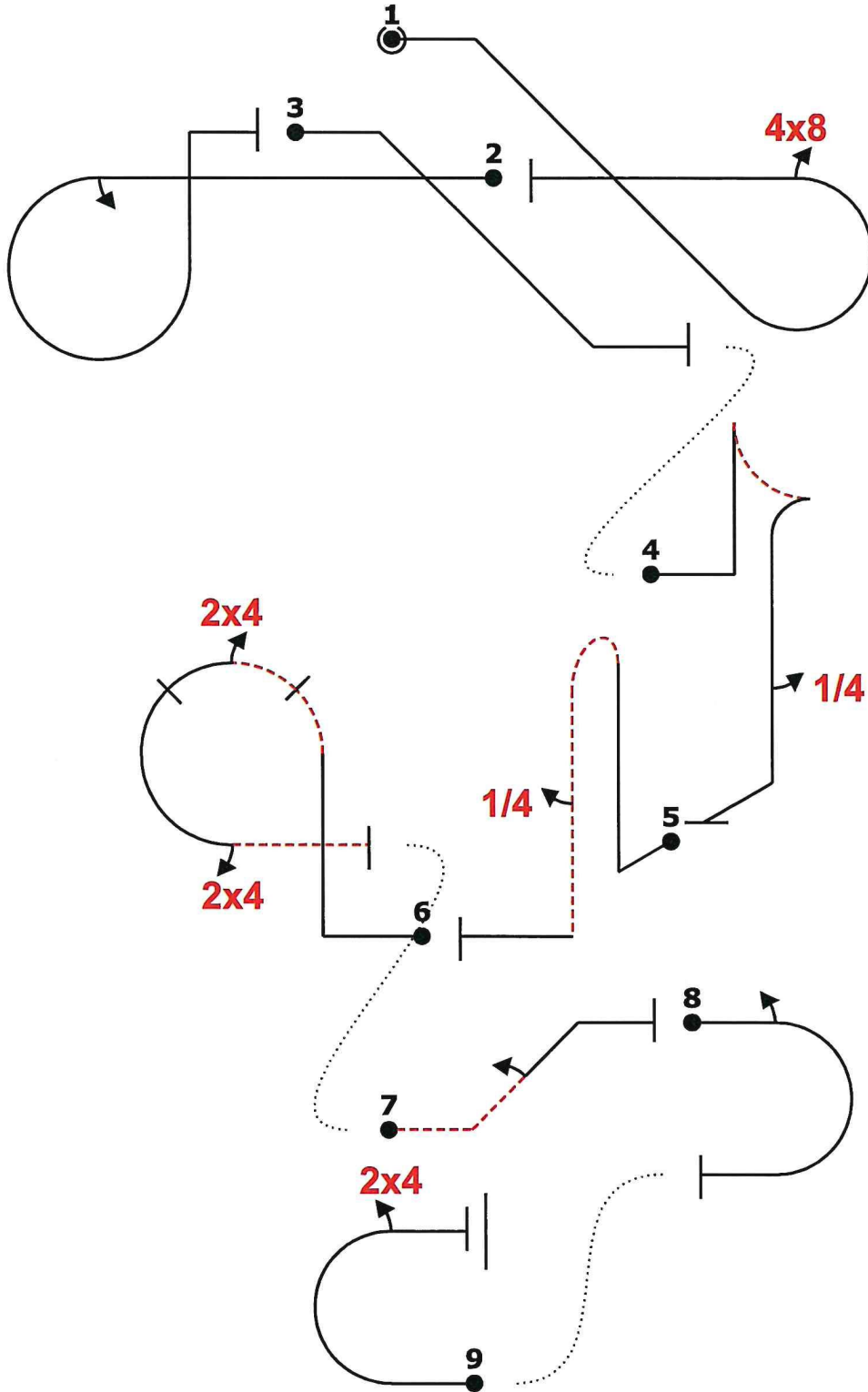

"@e" ..irc,48 "ec" 2% ...2ip... "el" id... "eg" (-6,12) ...+ita4.+ "e0" ...+pb,4. "eA" 2% ...rp(,24),24- "eB" (-3,15) -d2 "eL" 2a "eF" (-8,11) m24

Team Austria Pilot  
 Swift and Fox A/C

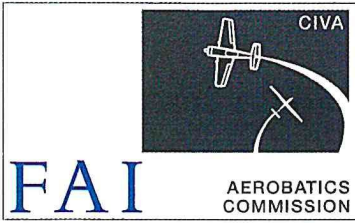

<b>Seq. L</b>		Form B
Pilot ID	CIVA Glider Advanced FreeUnknown	Flight #

L

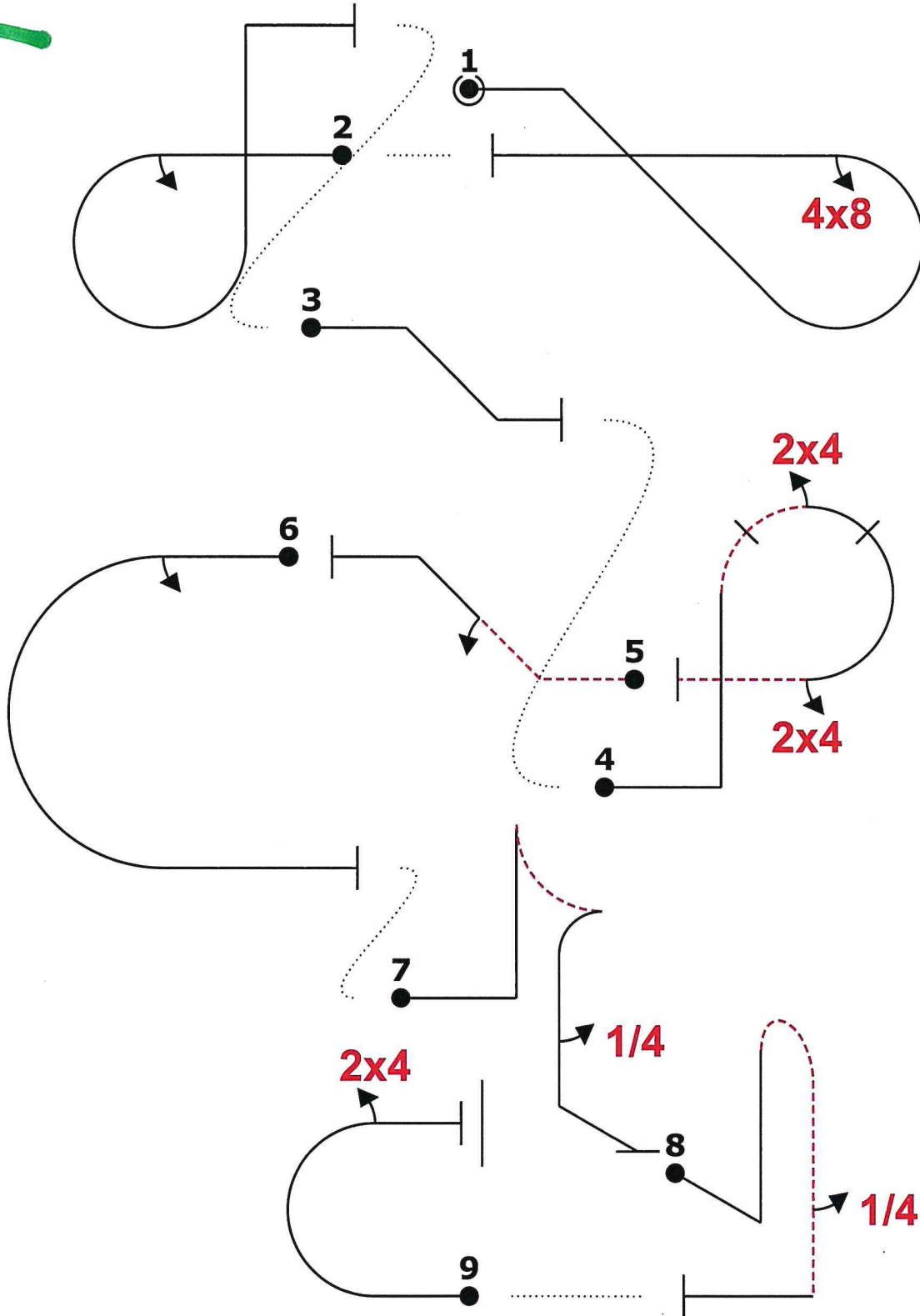

"0E" /irc48-- (-3,0) "0C" 2ip- (-6,14) "0L" id'+ (-2,17) "0A" -'xp(24)24- "0B" -d2 "0L" 88 '2a- (-2,6) "0G" ""+ita""4'+"" pb4 [-6,0] "0F" m24

