

FAI
AEROBATICS
COMMISSION

		Form B
Pilot ID	CIVA Glider Advanced FreeUnknown	Flight #

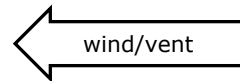

A

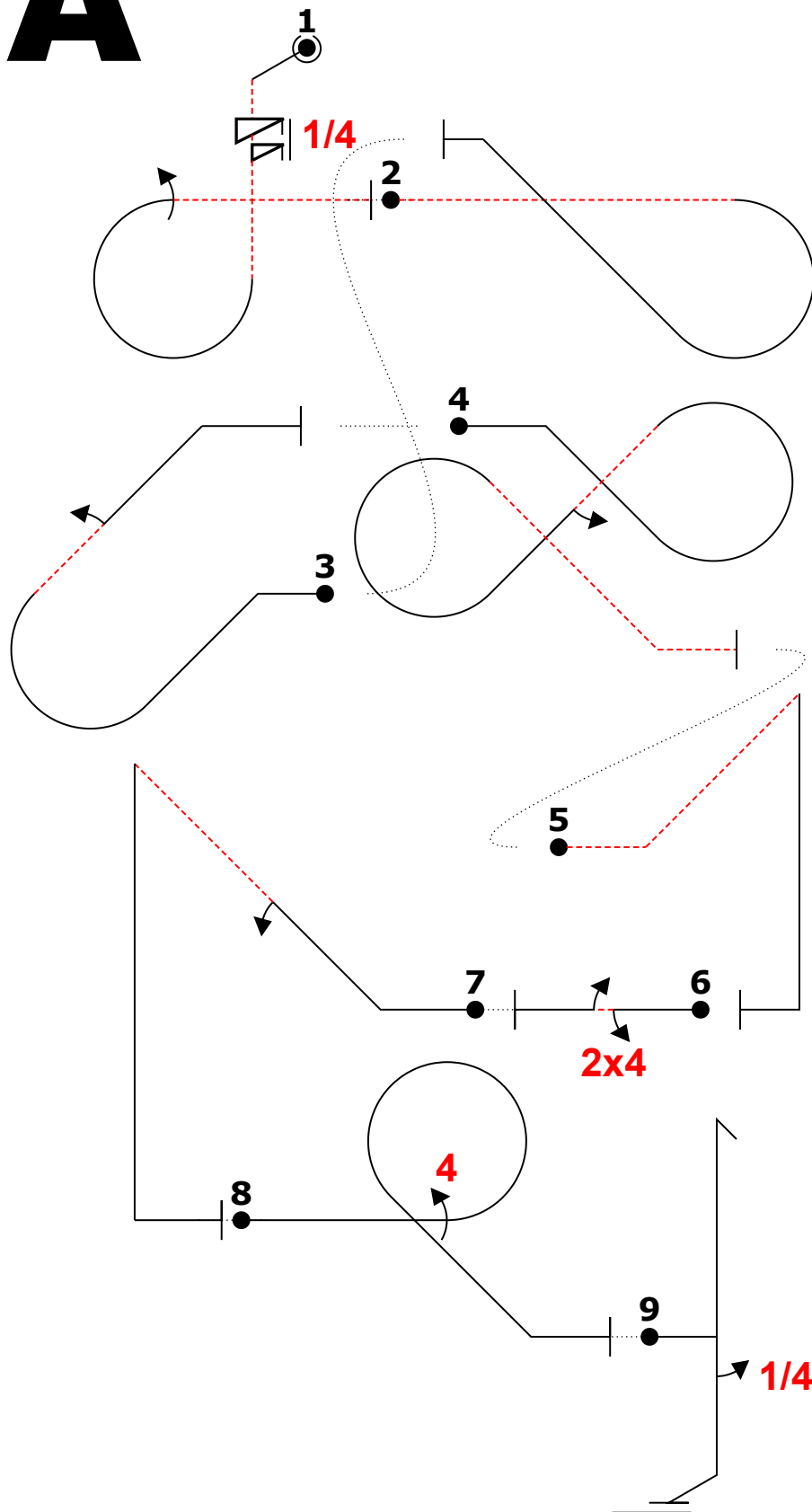

Glider			
Fig	Aresti	K	
1 B	8.6.3.3	13	31
	9.11.1.5	6	
	9.1.3.4	12	
2 Add.	8.5.5.4	10	5
3 E	8.4.18.3	13	22
	9.1.2.2	9	
4 A	7.8.11.3	22	28
	9.1.4.2	6	
5 Add.	1.2.2.2	13	5
6 C	1.1.1.1	2	16
	9.4.3.2	8	
	9.1.3.2	6	
7 D	1.2.3.1	12	21
	9.1.2.2	9	
8 F	8.7.5.1	11	28
	9.4.3.4	17	
9 G	5.2.1.1	17	20
	9.1.5.1	3	
Total K = 176 (max K = 170)			

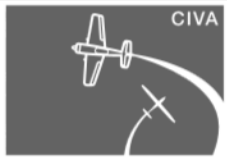

FAI

AEROBATICS COMMISSION

Pilot ID

CIVA Glider Advanced FreeUnknown

Form B

Flight #

B

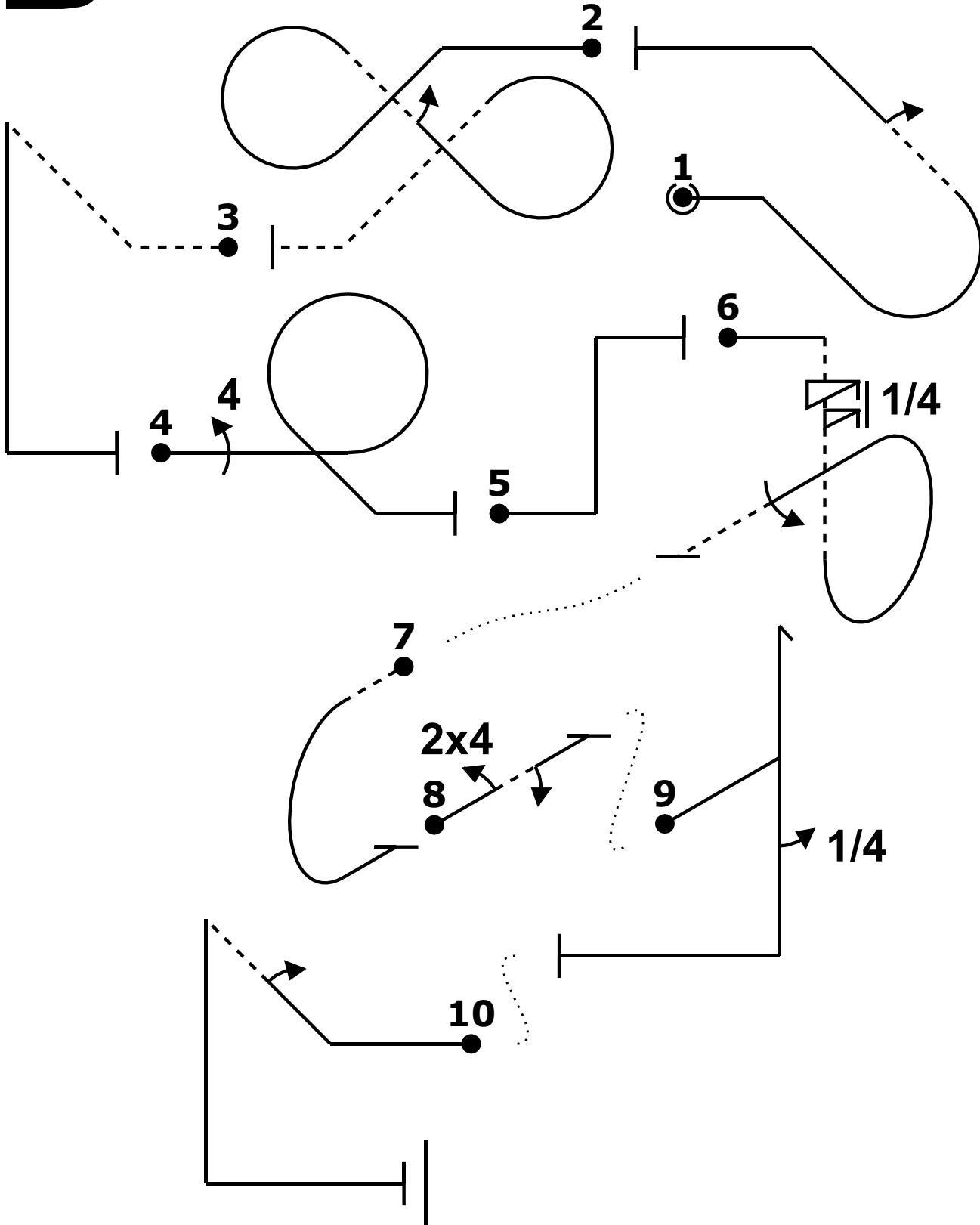
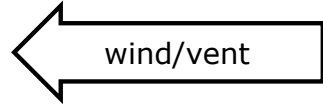

/ Pilot
 A/C

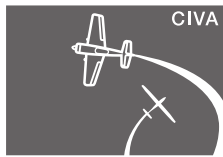

FAI

AEROBATICS
COMMISSION

WAGAC 2021

Form B

Pilot ID

CIVA Glider Advanced FreeUnknown

Flight #

C

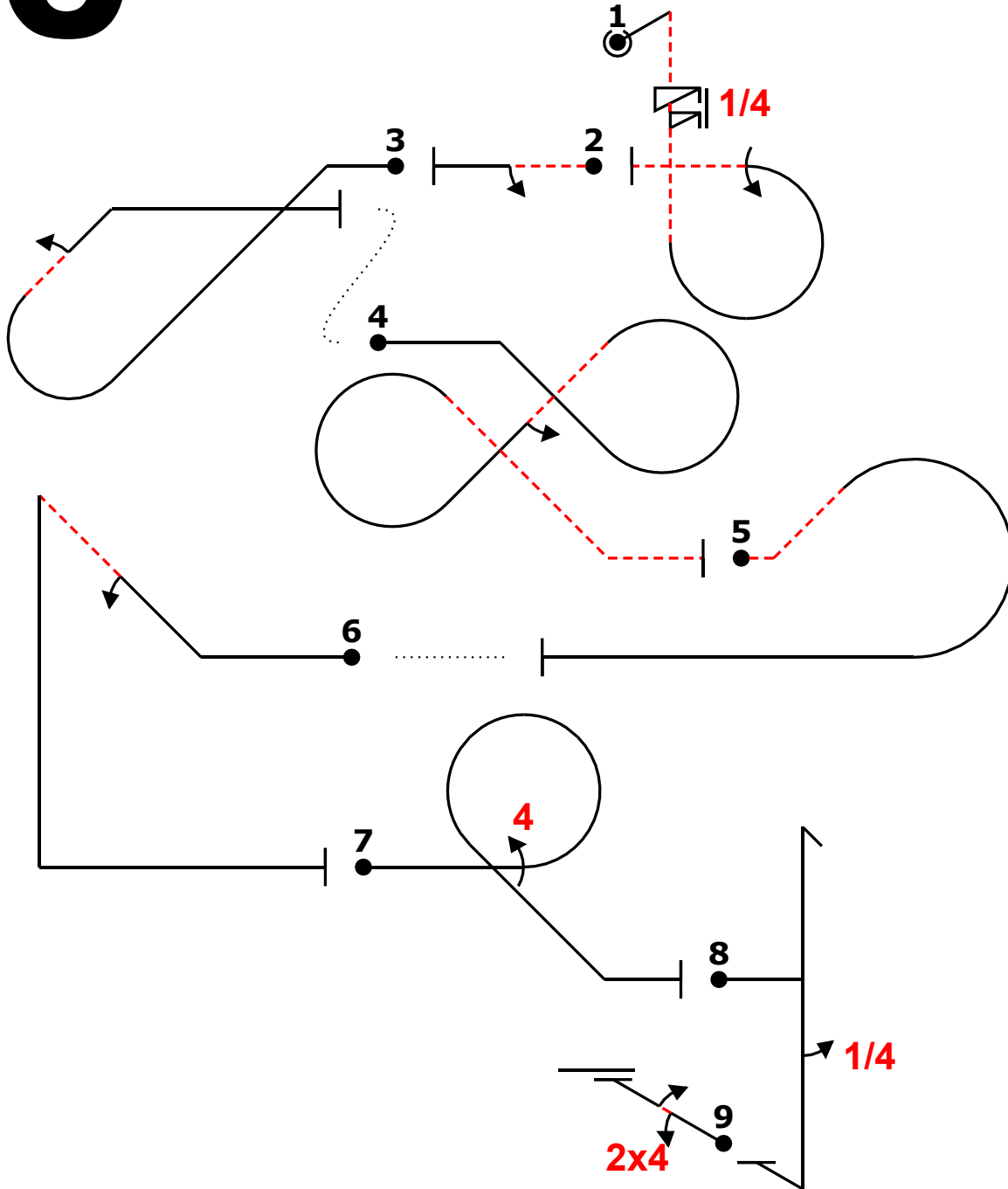
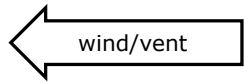

Glider			
Fig	Aresti	K	
1 B	8.6.3.3	13	31
	9.11.1.5	6	
	9.1.3.4	12	
2 Add.	1.1.1.4	2	5
	9.1.3.2	6	
3 E	8.4.18.3	13	22
	9.1.2.2	9	
4 A	7.8.11.3	22	28
	9.1.4.2	6	
5 Add.	8.5.1.2	10	5
6 D	1.2.3.1	12	21
	9.1.2.2	9	
7 F	8.7.5.1	11	28
	9.4.3.4	17	
8 G	5.2.1.1	17	20
	9.1.5.1	3	
9 C	1.1.1.1	2	16
	9.4.3.2	8	
	9.1.3.2	6	
Total K = 176 (max K = 170)			

eja "@B" '5sirr1-> "@L" -2 -2% "@E" ...indb`2''+ (-2,7) "@A" 'igg(2)-` 3% "@L"pc' (-6,0) "@D" 5% /~2t.''+ "@F" 44q " @G" h4.''^ "@C" 24,2

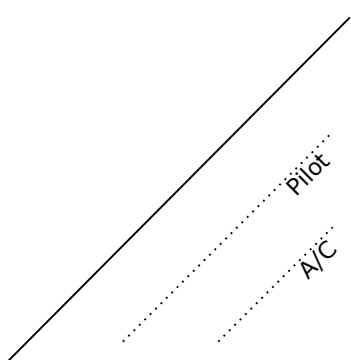



WAGAC Leszno 2021		Form B
Pilot ID	CIVA Glider Advanced FreeUnknown	Flight #

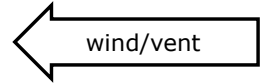

D

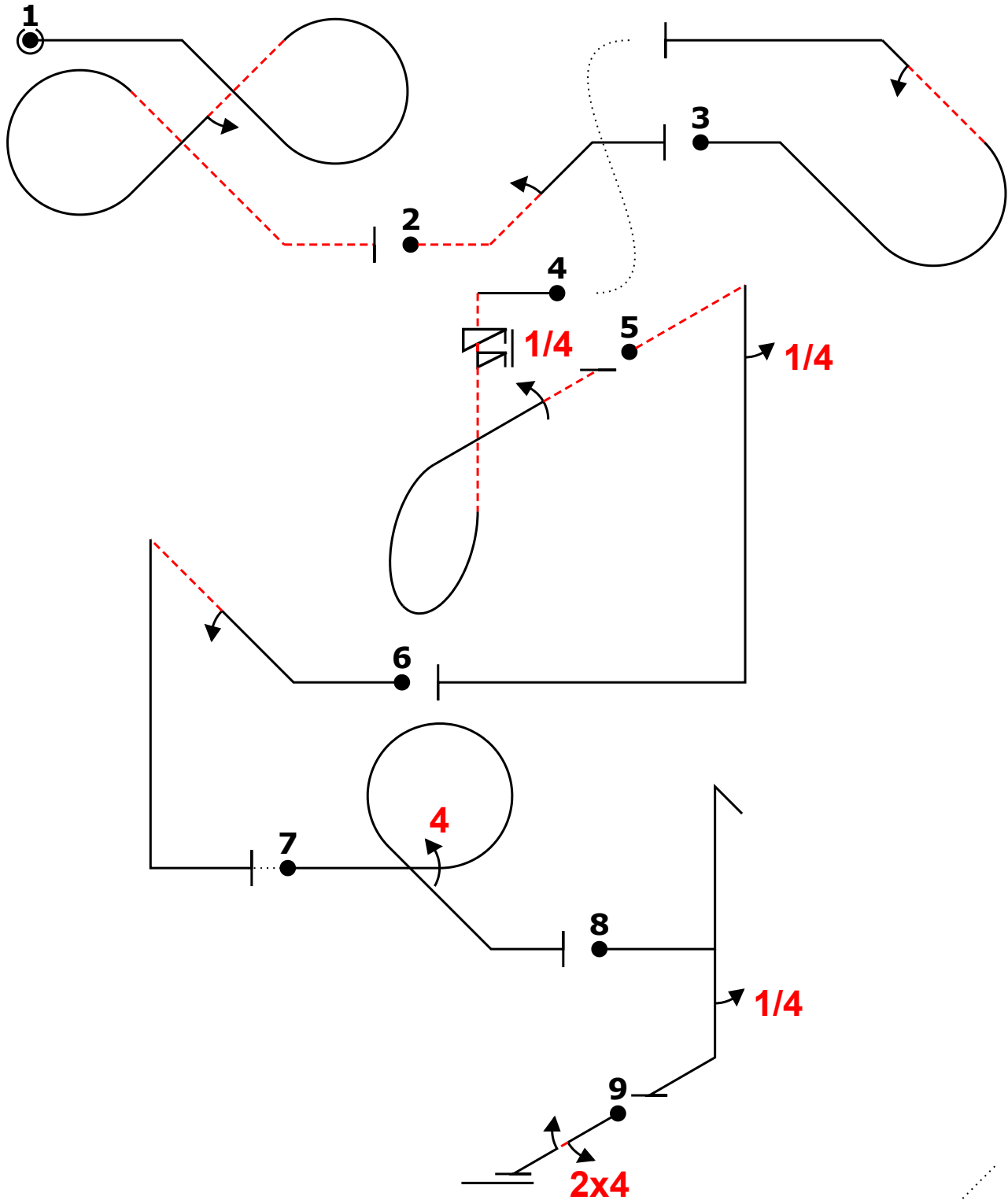

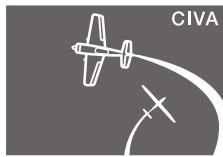

FAI

AEROBATICS COMMISSION

WAGAC 2021

Form B

Pilot ID

CIVA Glider Advanced FreeUnknown

Flight #

E

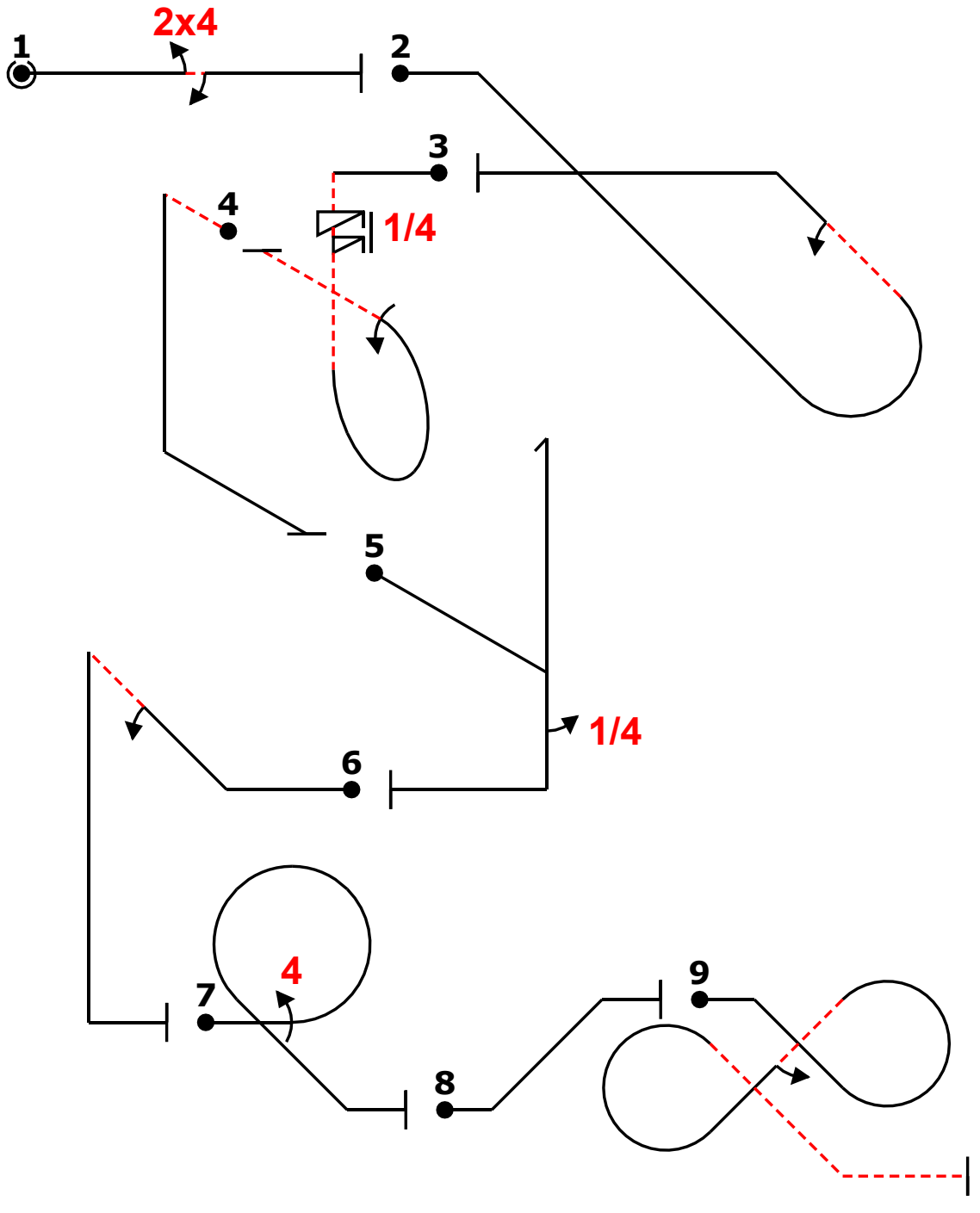
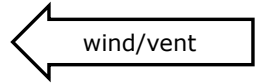

Glider			
Fig	Aresti	K	
1 C	1.1.1.1	2	16
	9.4.3.2	8	
	9.1.3.2	6	
2 E	8.4.18.3	13	22
	9.1.2.2	9	
3 B	8.6.3.3	13	31
	9.11.1.5	6	
	9.1.3.4	12	
4 Add.	1.1.7.4	9	5
5 G	5.2.1.1	17	20
	9.1.5.1	3	
6 D	1.2.3.1	12	21
	9.1.2.2	9	
7 F	8.7.5.1	11	28
	9.4.3.4	17	
8 Add.	1.1.2.1	7	5
9 A	7.8.11.3	22	28
	9.1.4.2	6	
Total K = 176		(max K = 170)	

@@C" . '24,2+~ "@E" -1%irdb2''+~w "@B" /~5sirp1~w^ "@L" 2% -iv.++ (0,0) "@G" ~+++.'h'4'+> "@D" ~~~'2t...'" "@F" ~~~~44q''+ "@L" ~+d+ "@A" -2% ~~~~~+igg(2)-

Pilot
A/C

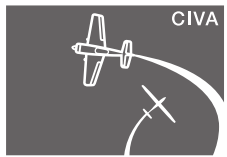

FAI

AEROBATICS COMMISSION

WAGAC 2021

Form B

Pilot ID

CIVA Glider Advanced FreeUnknown

Flight #

F

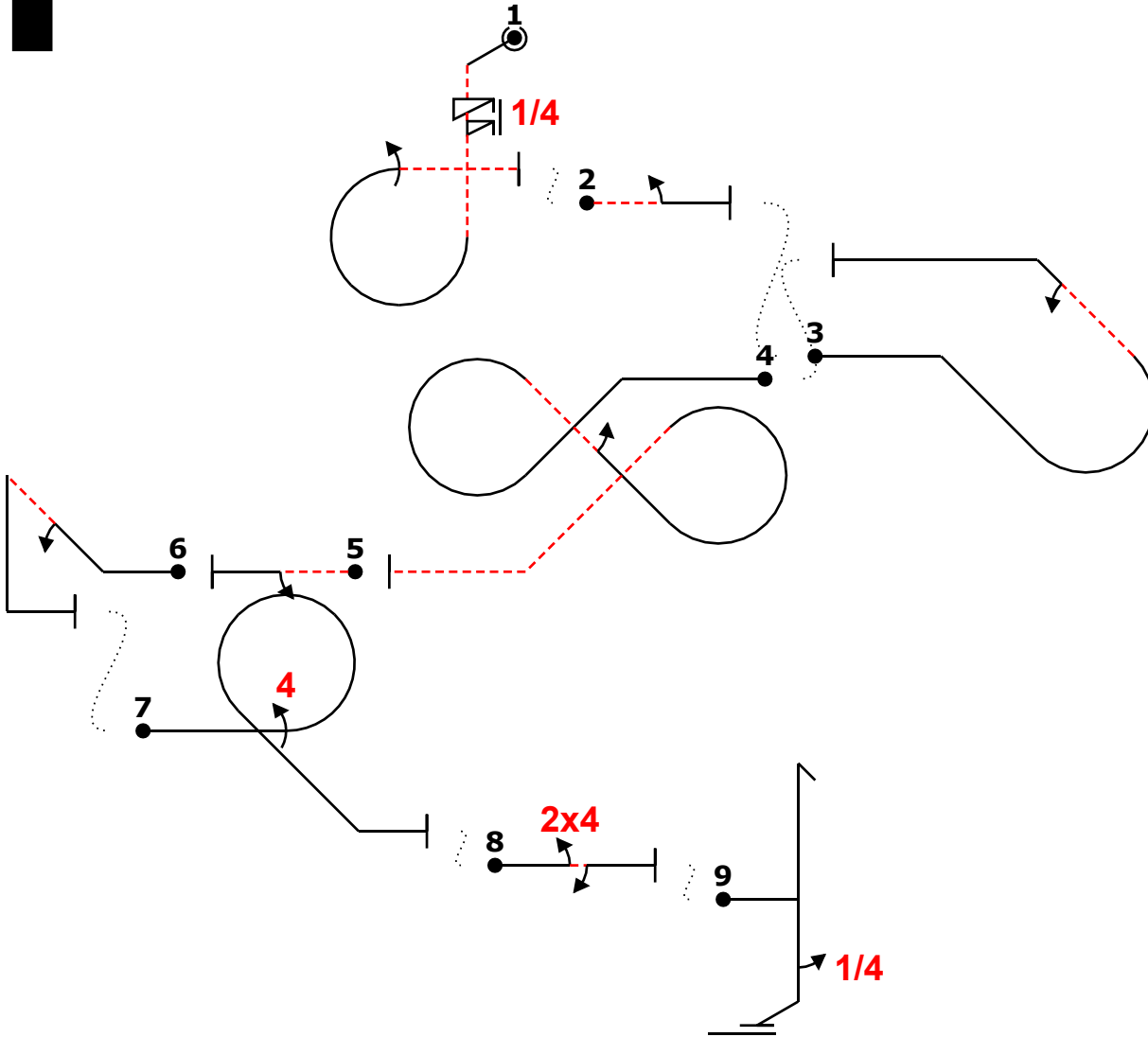
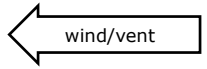

Glider			
Fig	Aresti	K	
1 B	8.6.3.3	13	31
	9.11.1.5	6	
	9.1.3.4	12	
2 Add.	1.1.1.4	2	5
	9.1.3.2	6	
3 E	8.4.18.3	13	22
	9.1.2.2	9	
4 A	7.8.11.3	22	28
	9.1.4.2	6	
5 Add.	1.1.1.4	2	5
	9.1.3.2	6	
6 D	1.2.3.1	12	21
	9.1.2.2	9	
7 F	8.7.5.1	11	28
	9.4.3.4	17	
8 C	1.1.1.1	2	16
	9.4.3.2	8	
	9.1.3.2	6	
9 G	5.2.1.1	17	20
	9.1.5.1	3	
Total K = 176 (max K = 170)			

Pilot
A/C

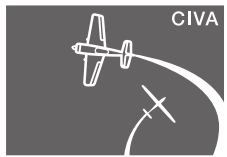

FAI

AEROBATICS COMMISSION

G

WAGAC 2021		Form B
Pilot ID	CIVA Glider Advanced FreeUnknown	Flight #

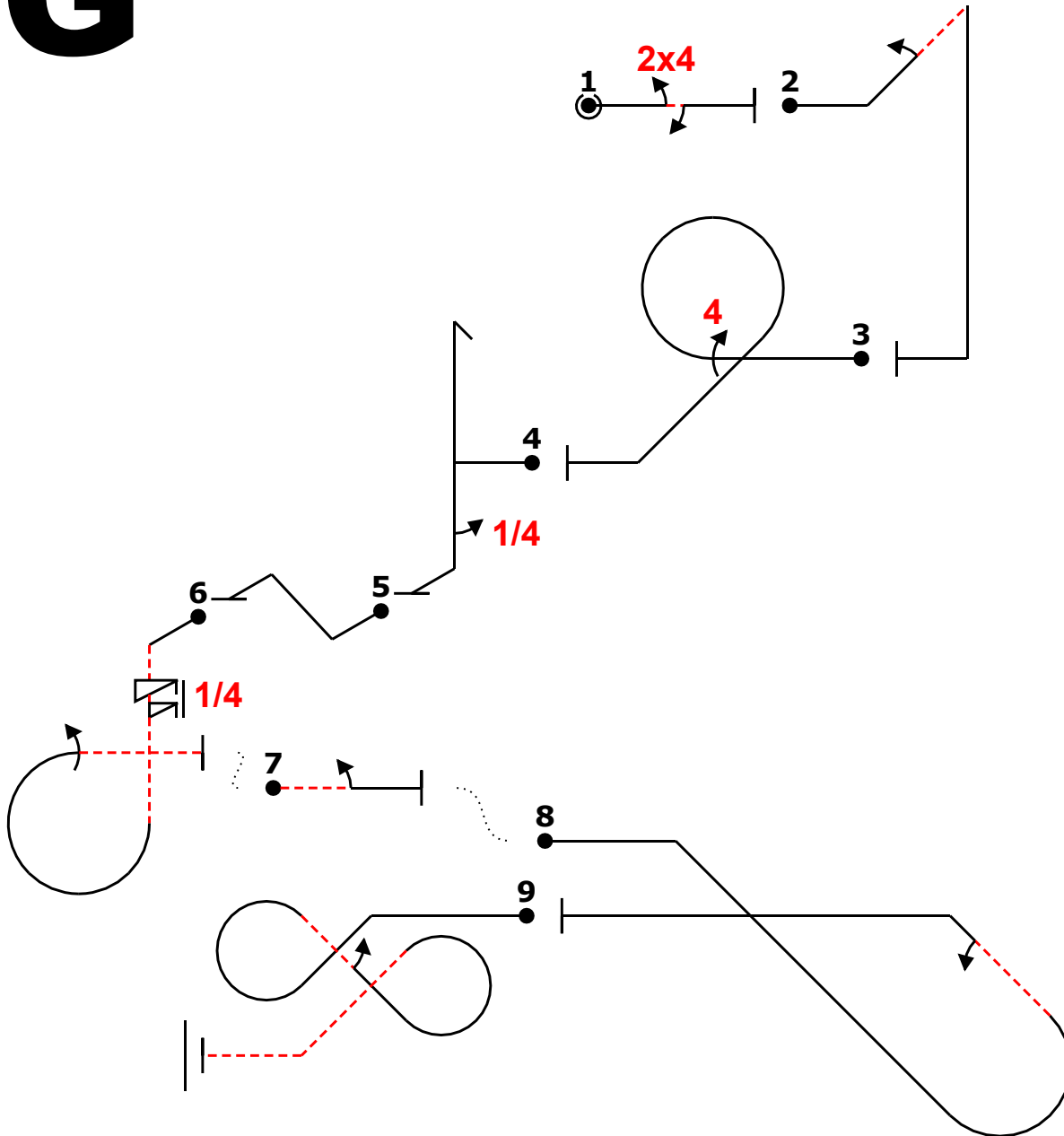
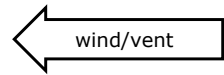

Glider			
Fig	Aresti	K	
1 C	1.1.1.1	2	16
	9.4.3.2	8	
	9.1.3.2	6	
2 D	1.2.3.1	12	21
	9.1.2.2	9	
3 F	8.7.5.1	11	28
	9.4.3.4	17	
4 G	5.2.1.1	17	20
	9.1.5.1	3	
5 Add.	1.1.2.1	7	5
6 B	8.6.3.3	13	31
	9.11.1.5	6	
	9.1.3.4	12	
7 Add.	1.1.1.4	2	5
	9.1.3.2	6	
8 E	8.4.18.3	13	22
	9.1.2.2	9	
9 A	7.8.11.3	22	28
	9.1.4.2	6	
Total K = 176 (max K = 170)			

