

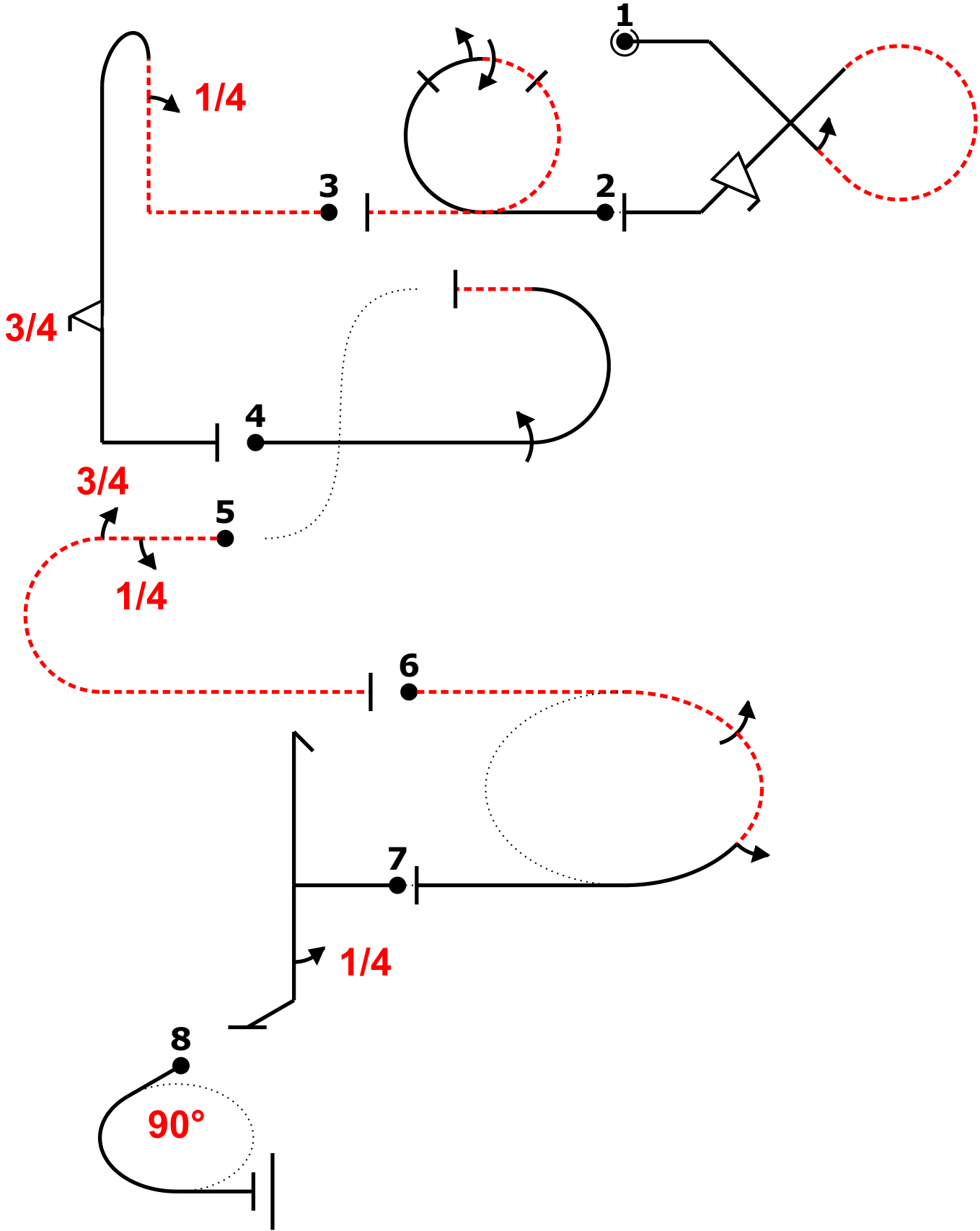

WGAC Oschatz 2024		Form B
Pilot ID	CIVA Glider Unlimited Free	
	Flight #	

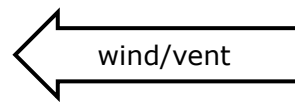

"@C" 2igf (3,0) "@A" o2,1- "@B" --,4b...,3f' "@G" ...'1m- (-8,13) "@E" -4,3a----- "@D" 8% -2jo15 (3,0) "@F" ~h4 "@L" 2> j

Steffen Engel Pilot
Swift S1b D-7125 A/C



WGAC Oschatz 2024		Form B
Pilot ID	CIVA Glider Unlimited Free	Flight #

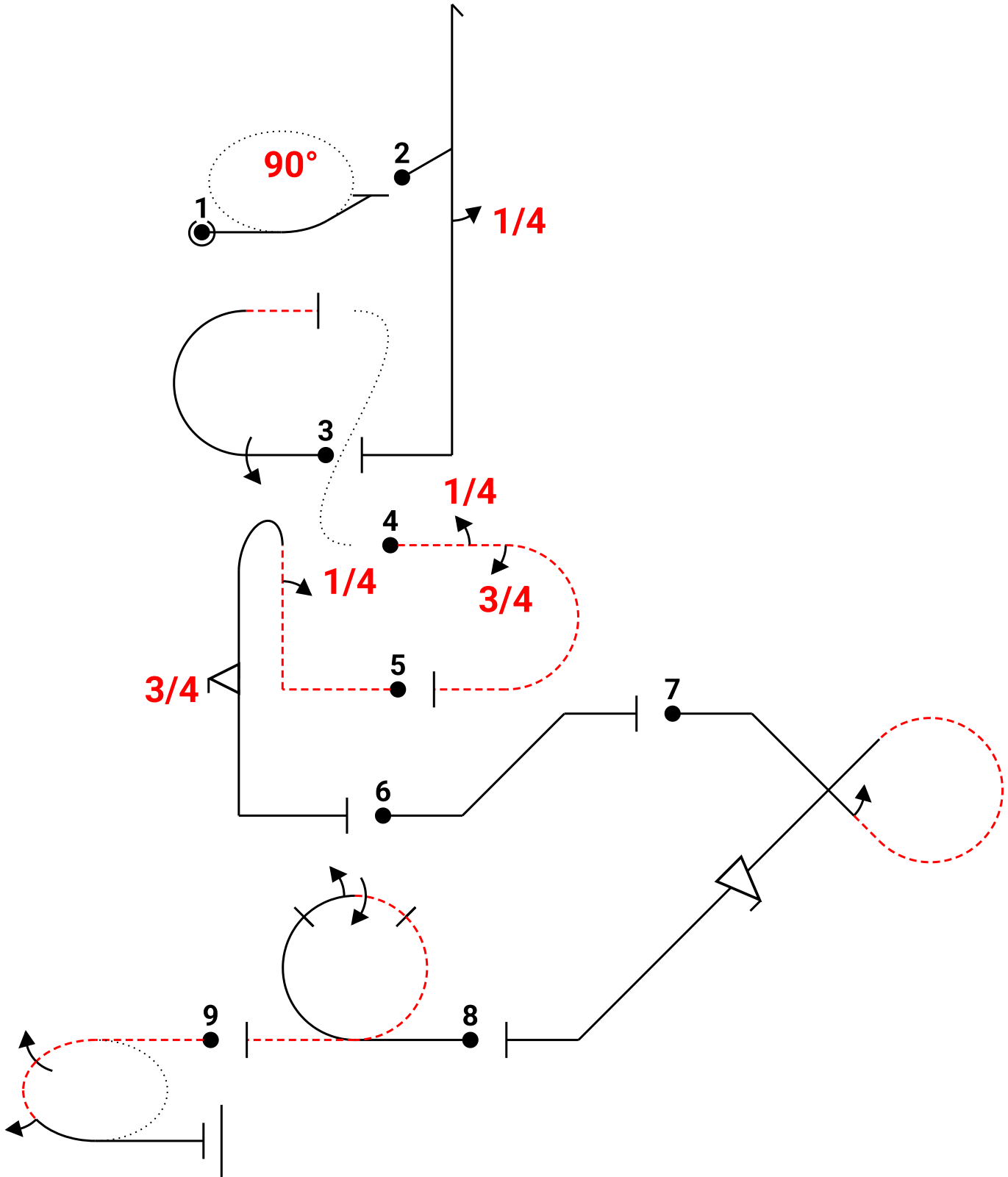
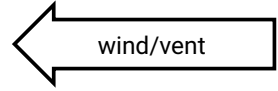

Moritz Kirchberg Pilot
 Swift D-3735 A/C



		Form B
Pilot ID	CIVA Glider Unlimited Free	Flight #

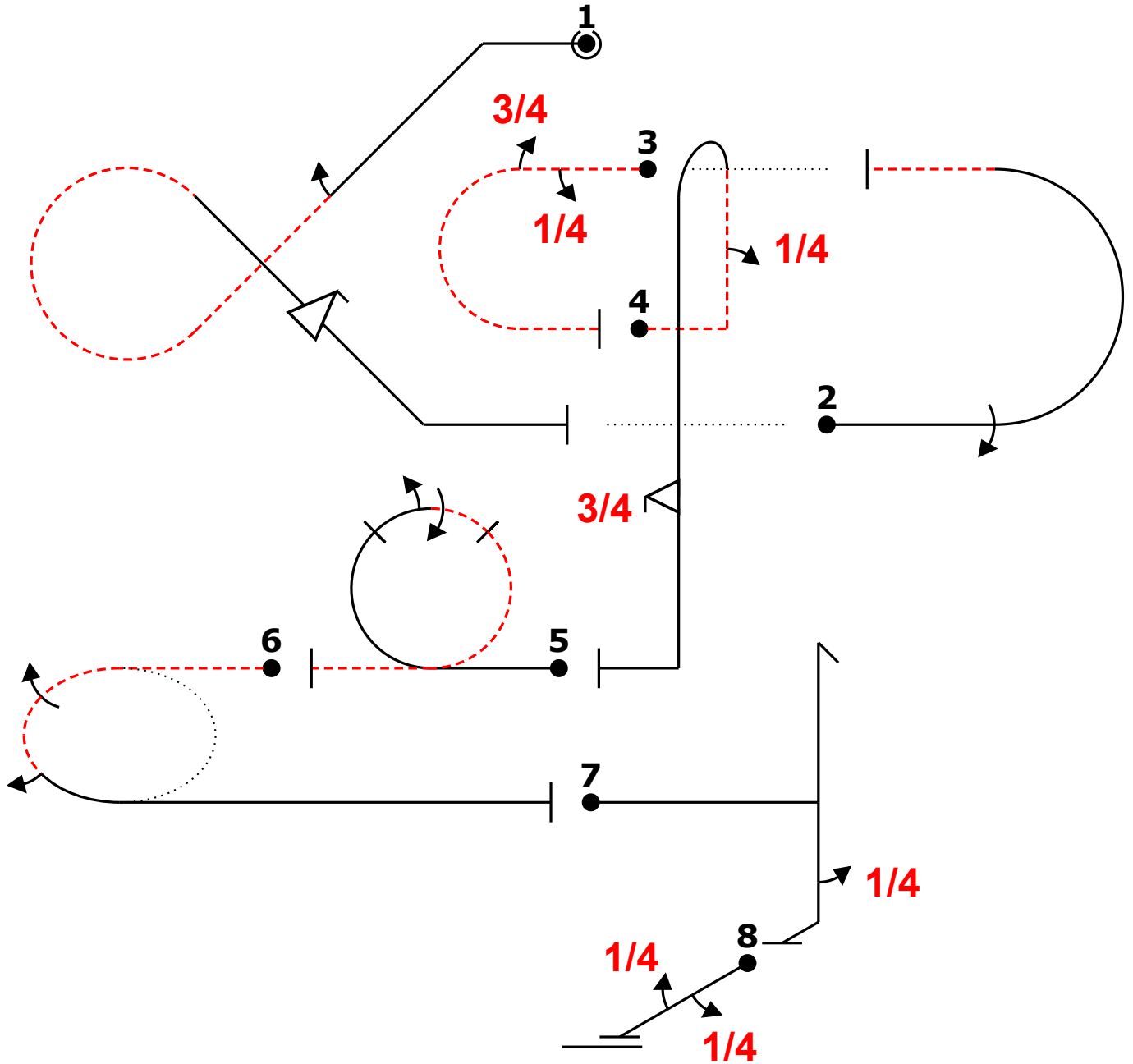
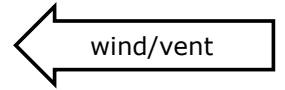

ed "@C" 2% ',2..ig`f.'~~ (9,0) "@G" 6% ~,1m- (-7,0) "@E" -4,3a- "@B" ~~-~,4''b...,3f.'+~~ "EA" o2,
 1- "@D" 2% -2jo15++++ "@F" ~+th4+~ "@L" 4,4

Eric Lentz Gauthier Pilot
 Swift OE 5707 A/C



		Form B
Pilot ID	CIVA Glider Unlimited Free	Flight #

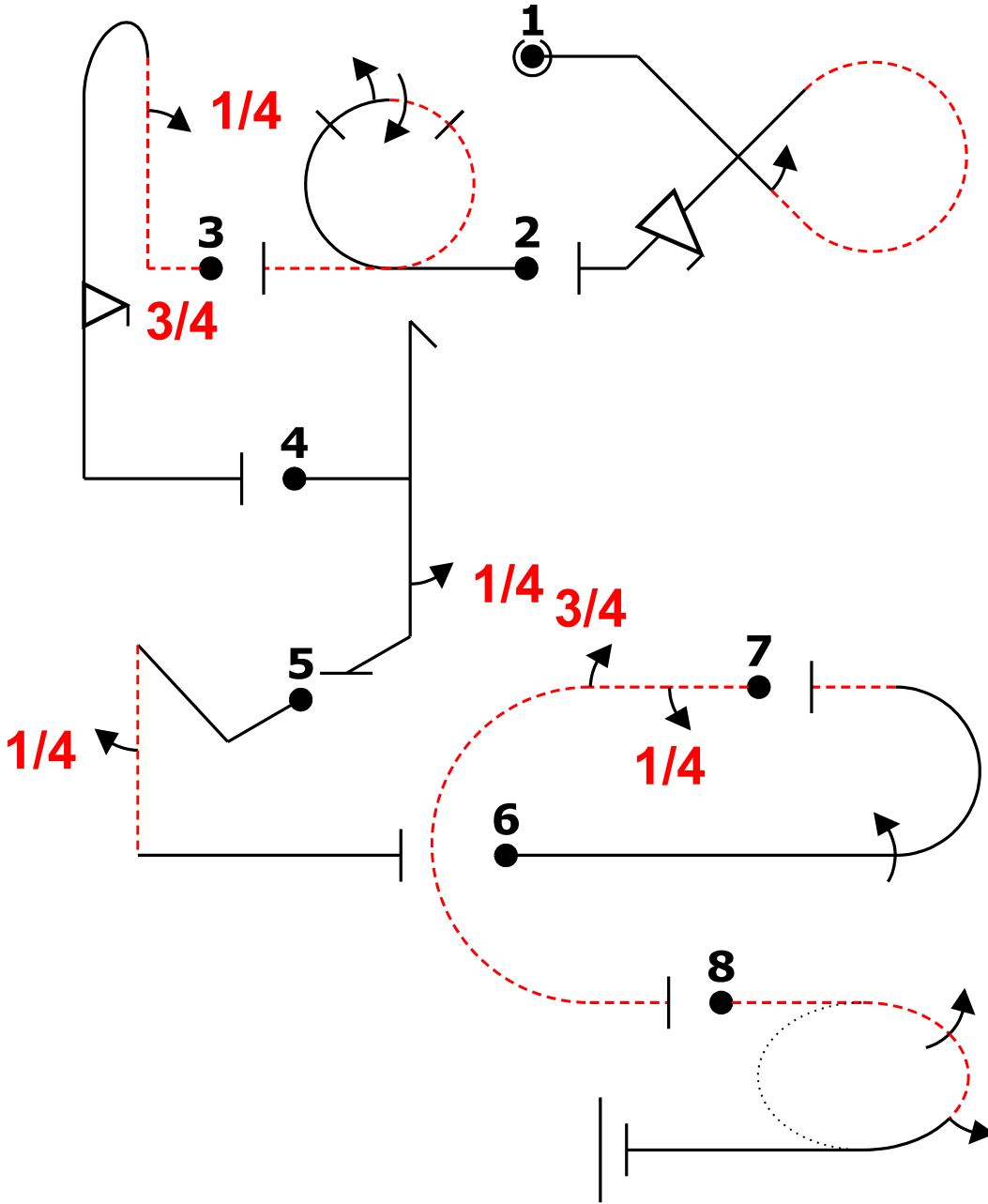
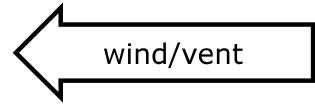

Glider			
Fig	Aresti	K	
1 C	7.3.2.3	17	39
	9.1.4.2	6	
	9.9.4.4	16	
2 A	7.4.2.1	12	30
	9.1.3.2	6	
	9.1.3.4	12	
3 B	8.4.4.2	14	37
	9.1.1.1	9	
	9.9.5.3	14	
4 F	5.2.1.1	17	20
	9.1.5.1	3	
5 Add.	1.2.1.1	13	10
	9.1.5.1	3	
6 G	7.2.1.1	6	18
	9.1.3.4	12	
7 E	7.2.3.4	9	21
	9.1.3.1	3	
	9.1.3.3	9	
8 D	2.2.3.4	35	35
Total K = 210 (max K = 210)			

Oliver ADAMY Pilot
MDM-1 FOX OK-400r A/C



		Form B
Pilot ID	CIVA Glider Unlimited Free	
	Flight #	

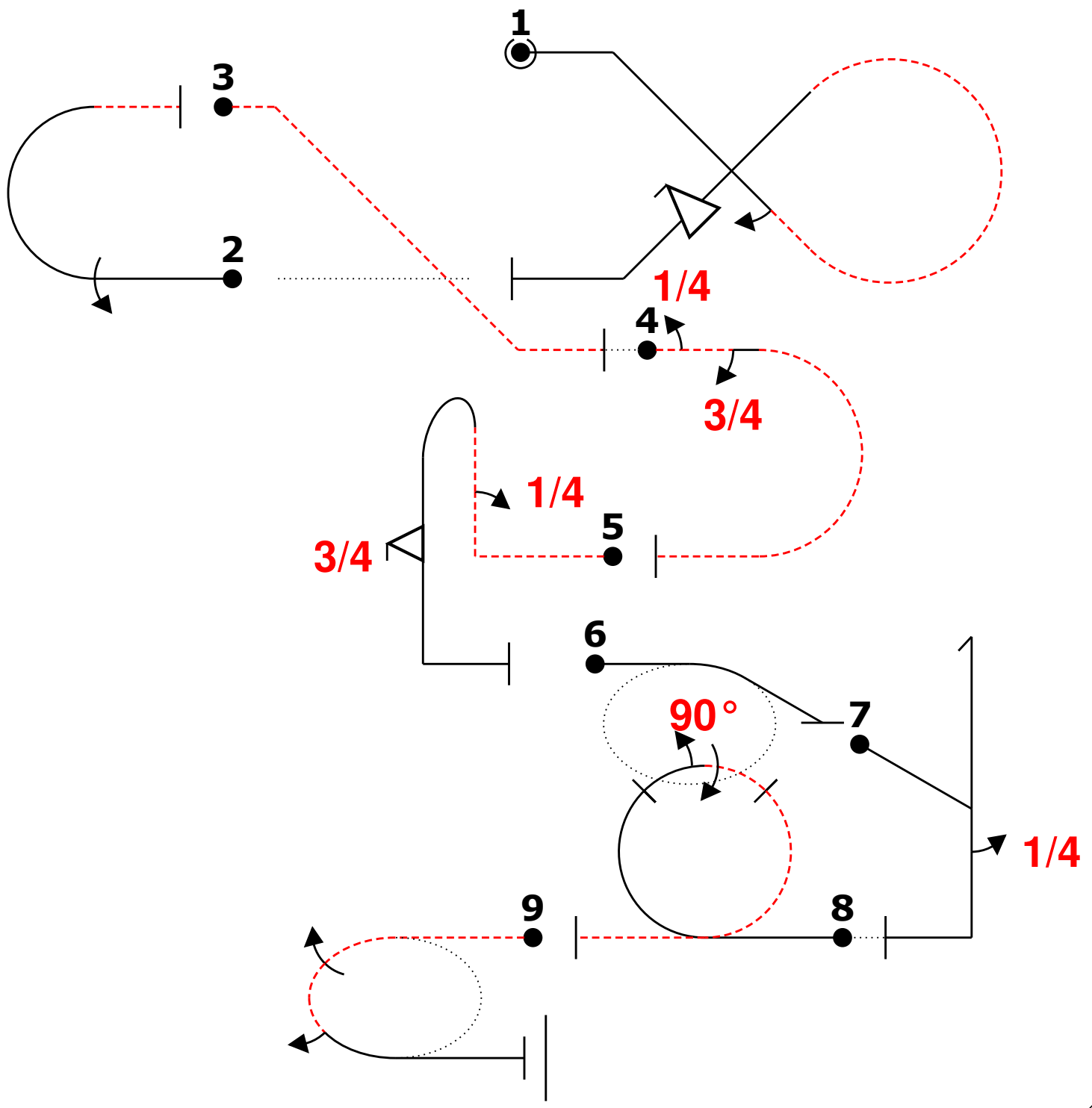
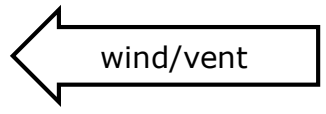

Mirosław Wrzesniewski
 Pilot
 S1 SP-3532
 A/C



		Form B
Pilot ID	CIVA Glider Unlimited Programme 3	Flight #

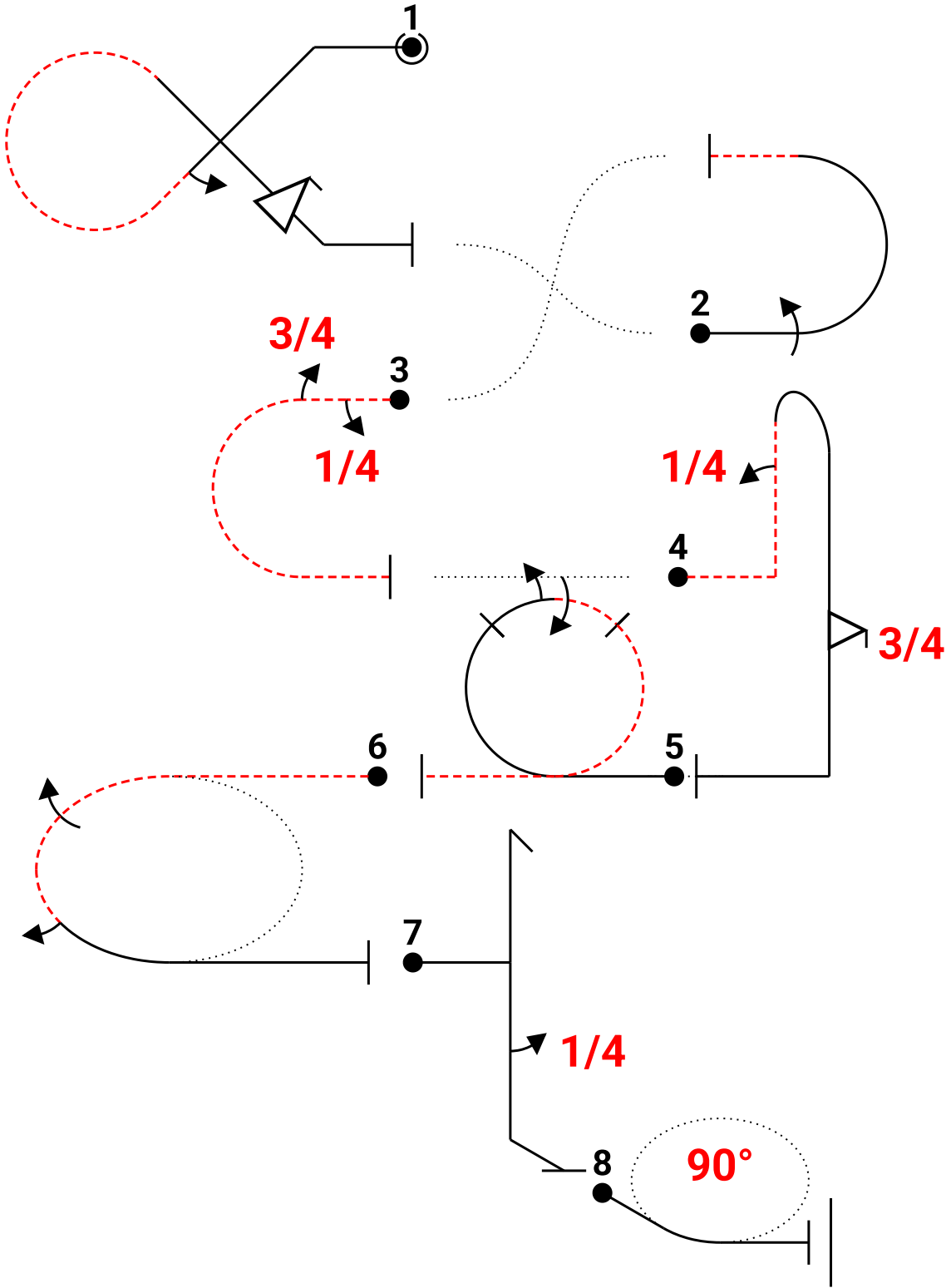
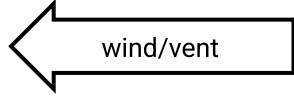

ed "@C" /2igf (9,4) "@G" 1m. (.10,11) "@E" 114,3a. (9,0) "@B" 114b'13f'1' (3,F.CH0) "@A" 1+o2,1. "@D" 5% .2jo15 "@F" 11h4'1' "@L" j>

Marc DE BOUVIER DE CACHARD
 Pilot
 SWIFT F-CHBA
 A/C



WGAC 02.08.2024		Form B
Pilot ID	CIVA Glider Unlimited Free	Flight #

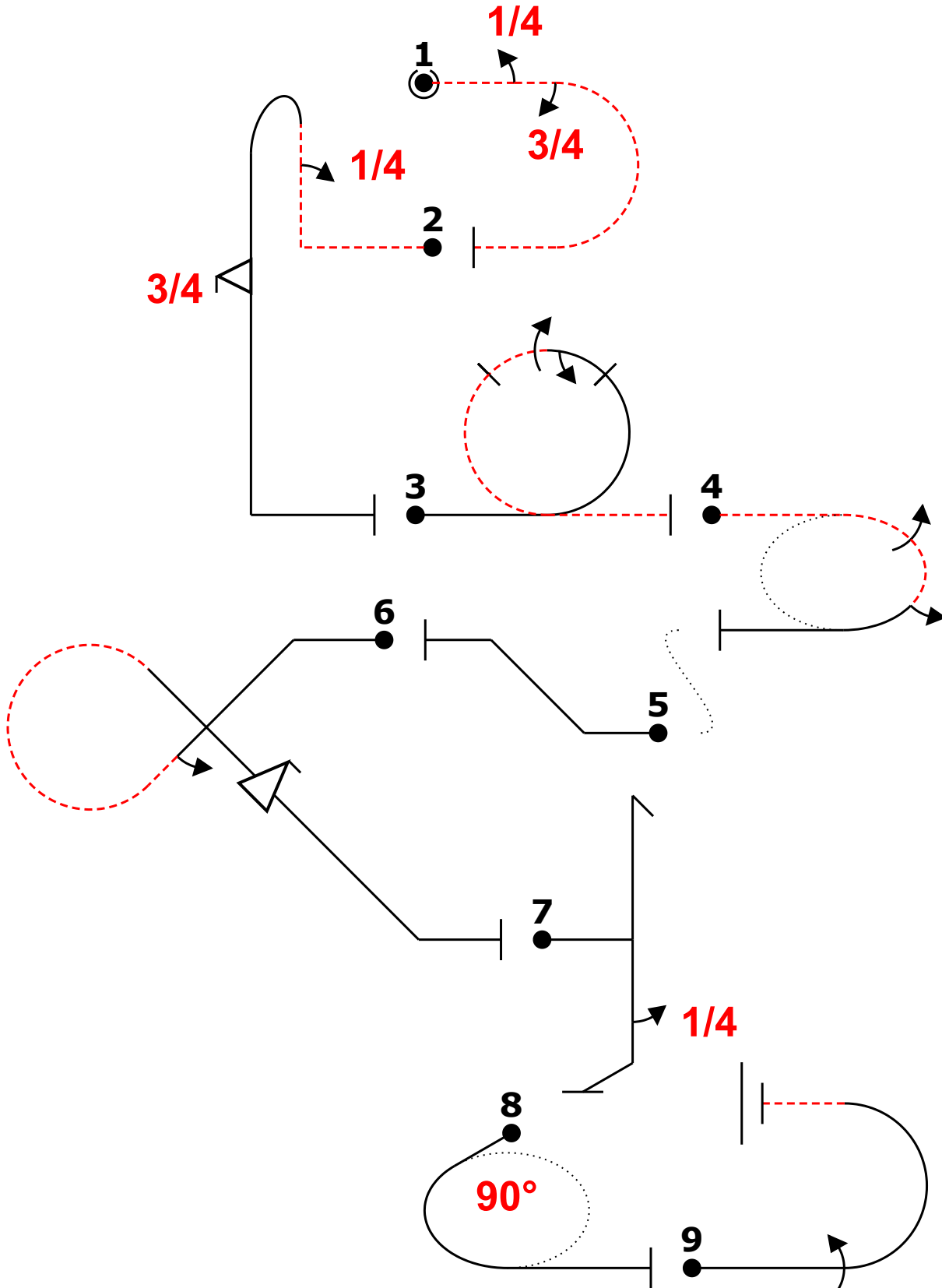
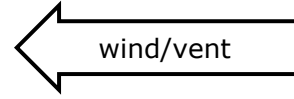

"@E" -4,3a- "@B" -",4b,3f...' "@A" o2,1- "@D" -2jo15 (1,5) "@L" -2% d "@C" 2ig1f...' "@F" `h4 "@L" 2> j+> "@G" .1m-

Jonas Langenegger
 Pilot
 Swift HB-3126
 A/C



		Form B
Pilot ID	CIVA Glider Unlimited Free	Flight #

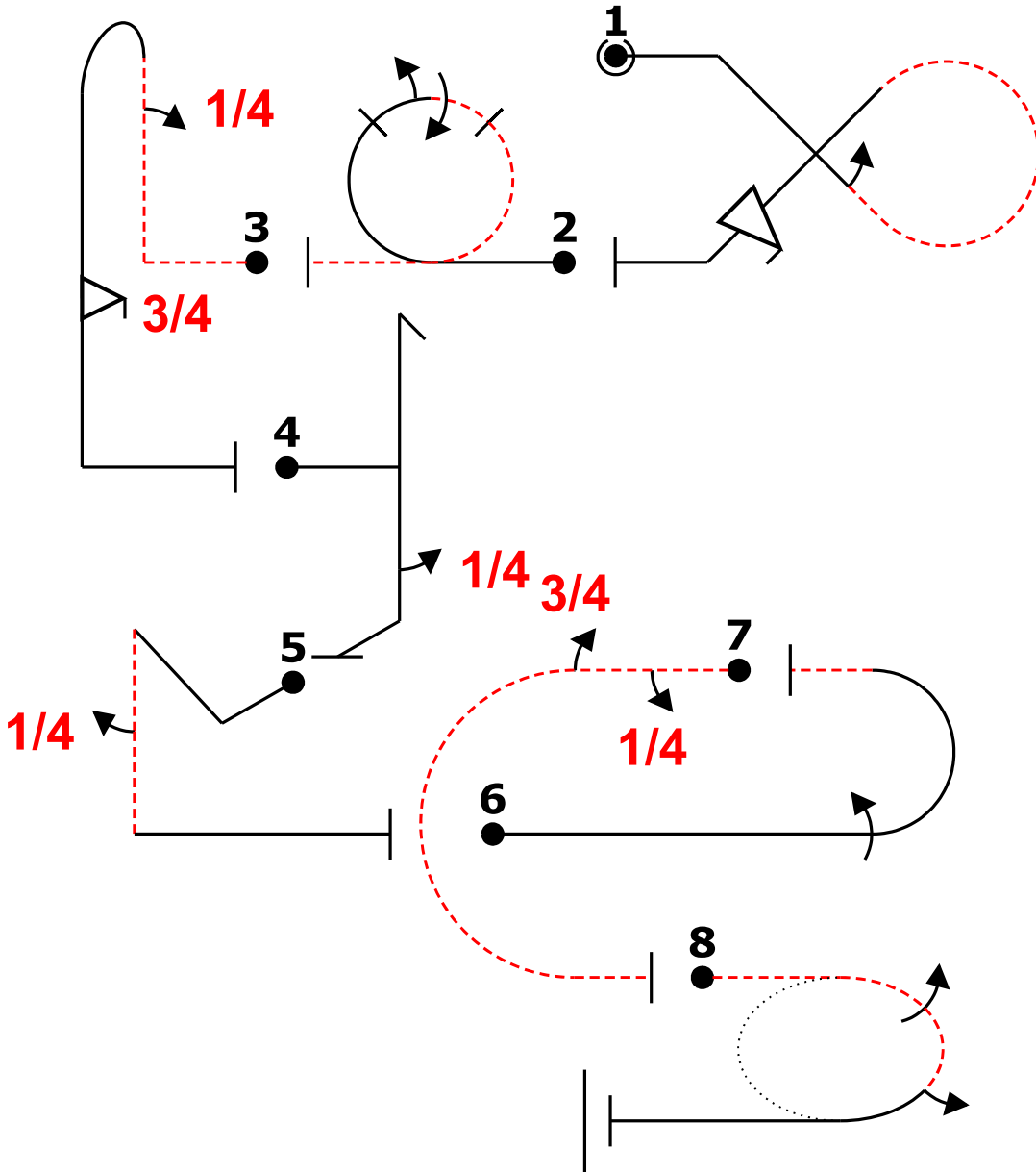

Glider			
Fig	Aresti	K	
1 C	7.3.2.3	17	39
	9.1.4.2	6	
	9.9.4.4	16	
2 A	7.4.2.1	12	30
	9.1.3.2	6	
	9.1.3.4	12	
3 B	8.4.4.2	14	37
	9.1.1.1	9	
	9.9.5.3	14	
4 F	5.2.1.1	17	20
	9.1.5.1	3	
5 Add.	1.2.1.1	13	10
	9.1.5.1	3	
6 G	7.2.1.1	6	18
	9.1.3.4	12	
7 E	7.2.3.4	9	21
	9.1.3.1	3	
	9.1.3.3	9	
8 D	2.2.3.4	35	35
Total K = 210 (max K = 210)			

Přemysl VÁVRA Pilot
Swift S1 OK-2151 A/C



		Form B
Pilot ID	CIVA Glider Unlimited Free	
	Flight #	

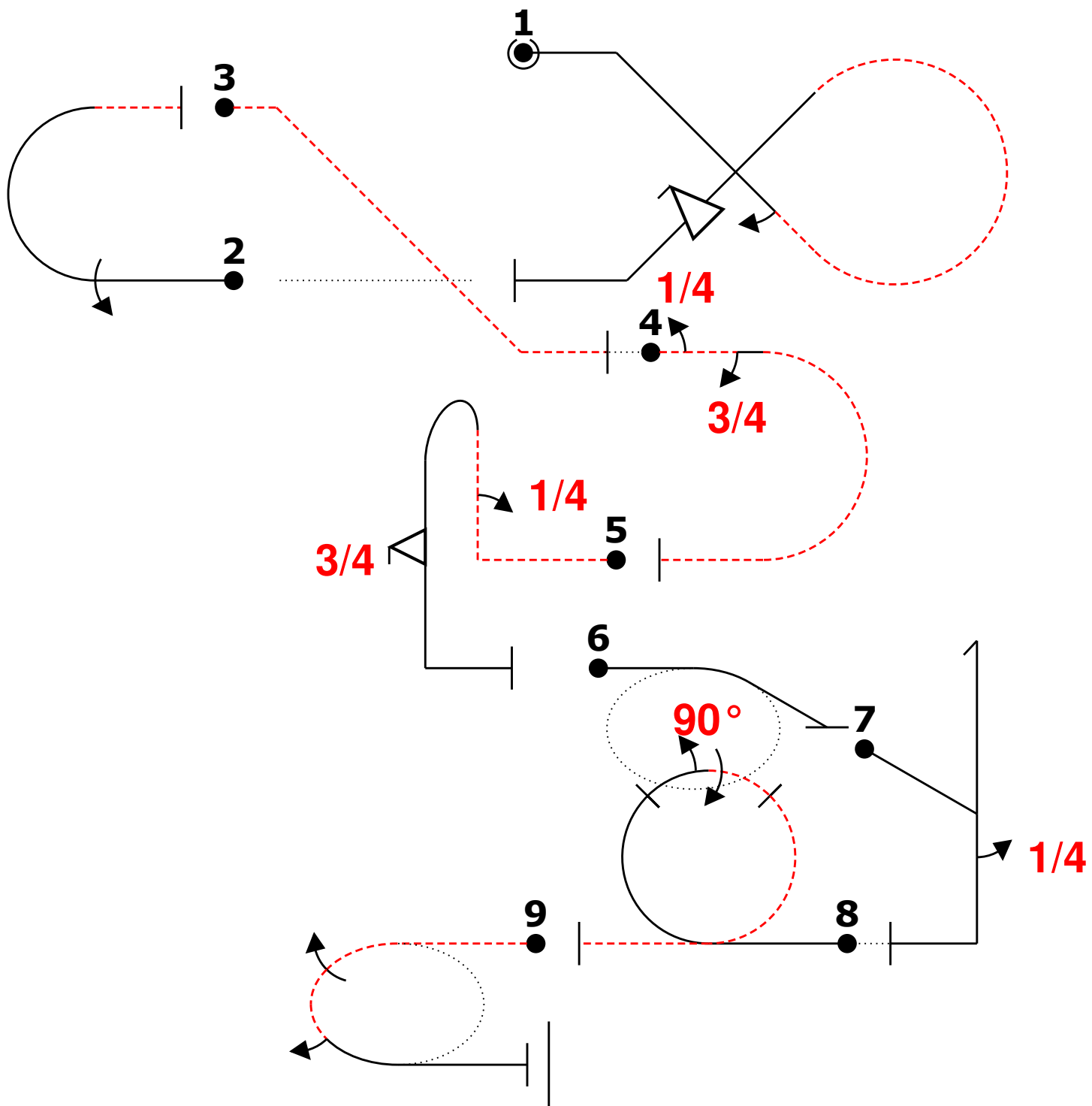
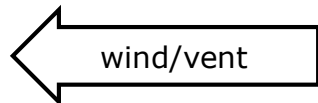

Maciej Pospieszynski
 S1 SP-3532
 Pilot
 A/C



		Form B
Pilot ID	CIVA Glider Unlimited Free	Flight #

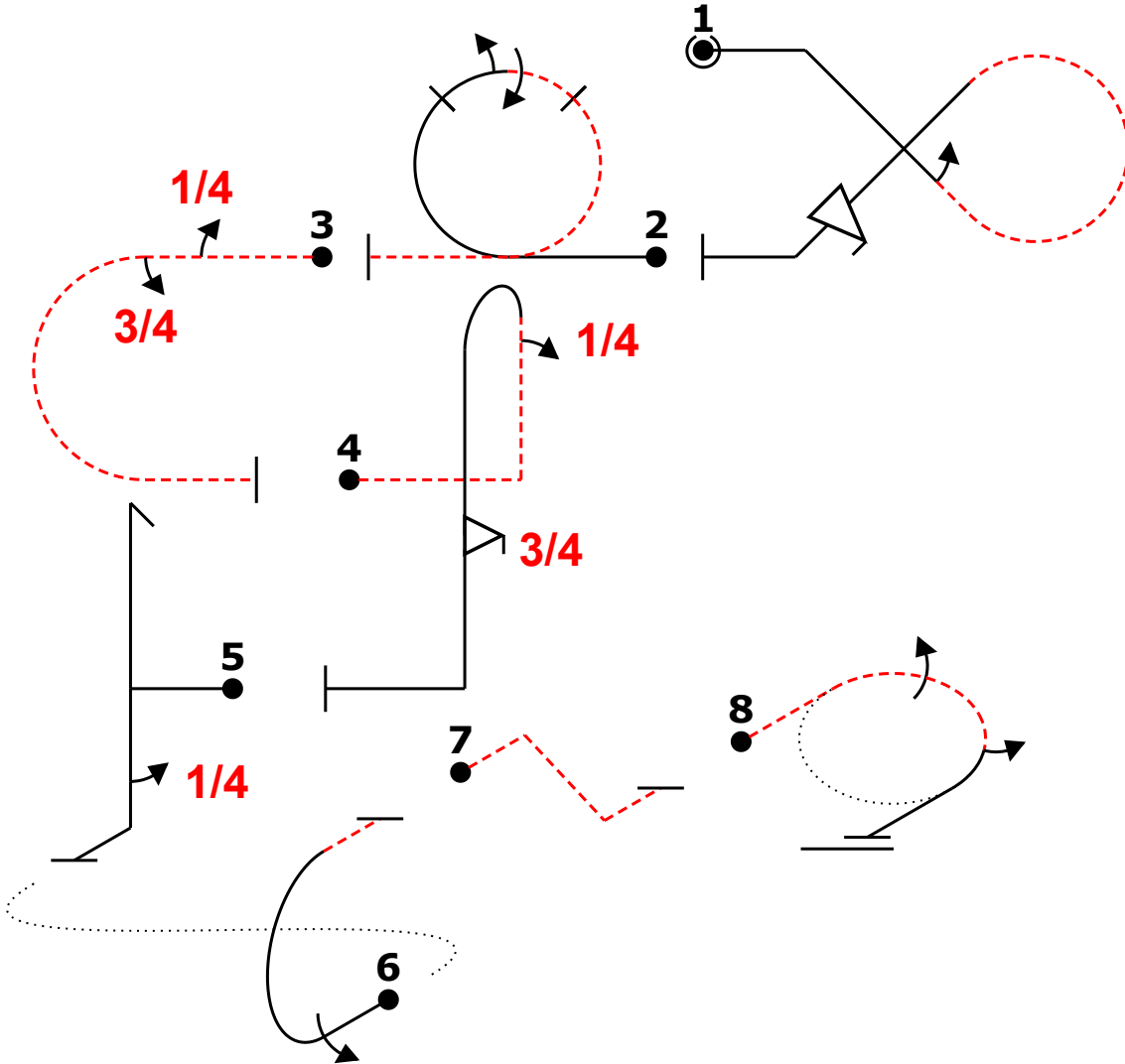
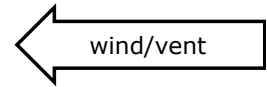

Glider			
Fig	Aresti	K	
1 C	7.3.2.3	17	39
	9.1.4.2	6	
	9.9.4.4	16	
2 A	7.4.2.1	12	30
	9.1.3.2	6	
	9.1.3.4	12	
3 E	7.2.3.4	9	21
	9.1.3.1	3	
	9.1.3.3	9	
4 B	8.4.4.2	14	37
	9.1.1.1	9	
	9.9.5.3	14	
5 F	5.2.1.1	17	20
	9.1.5.1	3	
6 G	7.2.1.1	6	18
	9.1.3.4	12	
Add.	1.1.2.4	8	10
8 D	2.2.3.4	35	
		35	
Total K = 210 (max K = 210)			

Pilot
A/C
Pietro Filippini

Free Gisbert Leimkühler



WGAC 2024 Oschatz 2024		Form B
Pilot ID	CIVA Glider Unlimited Free	
	Flight #	

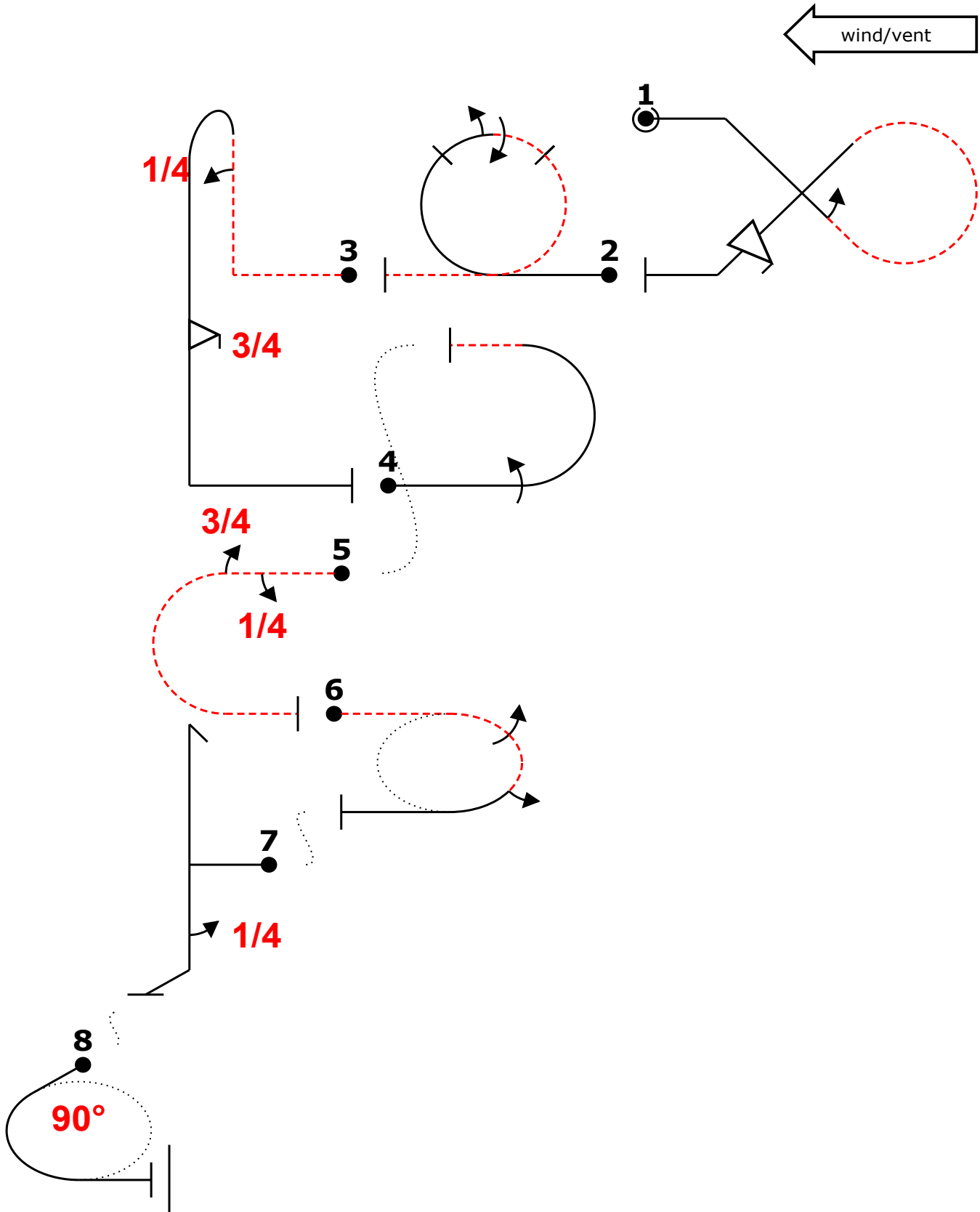

"@C" 2igf "@A" o2,1- "@B" -4b.'3f.'+ "@G" .1m- (-2,13) "@E" -4,3a- "@D" -2jo15 (0,3) "@F" h4 (0,2) "@L" j

Gisbert Leimkühler
Pilot
Swift S1 D-3168
A/C



WGAC 2024		Form B
Pilot ID	CIVA Glider Unlimited Free	Flight #

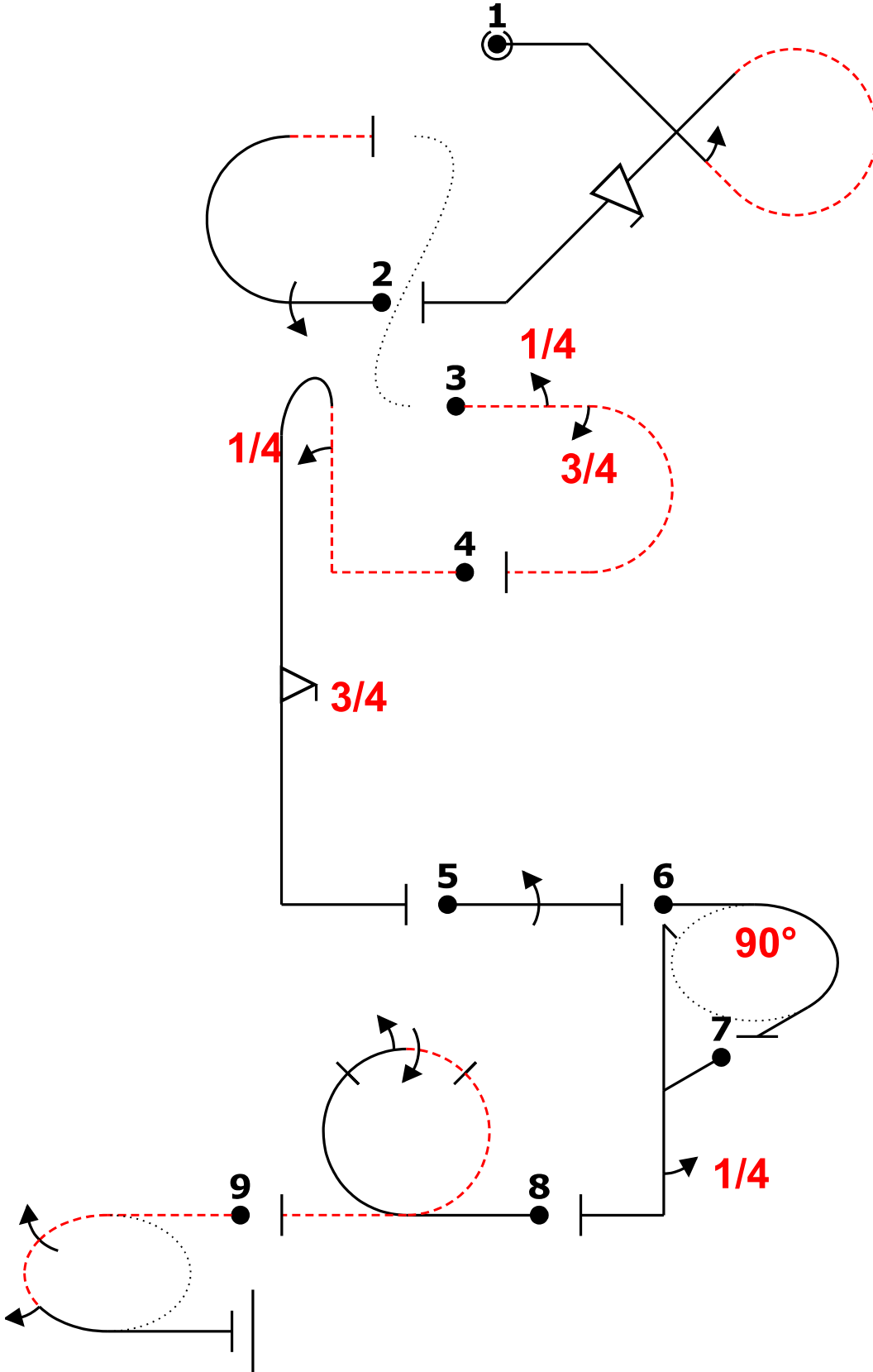
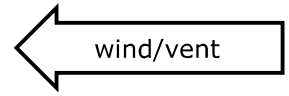

Glider			
Fig	Aresti	K	
1 C	7.3.2.3	17	39
	9.1.4.2	6	
	9.9.4.4	16	
2 G	7.2.1.1	6	18
	9.1.3.4	12	
3 E	7.2.3.4	9	21
	9.1.3.1	3	
	9.1.3.3	9	
4 B	8.4.4.2	14	37
	9.1.1.1	9	
	9.9.5.3	14	
5 Add.	1.1.1.1	2	5
	9.1.3.4	12	
6 Add.	2.1.1.1	3	5
7 F	5.2.1.1	17	20
	9.1.5.1	3	
8 A	7.4.2.1	12	30
	9.1.3.2	6	
	9.1.3.4	12	
9 D	2.2.3.4	35	35
Total K = 210 (max K = 210)			

Jakob Prior Pilot
 S1 Swift D-9590 A/C



		Form B
Pilot ID	CIVA Glider Unlimited Free	Flight #

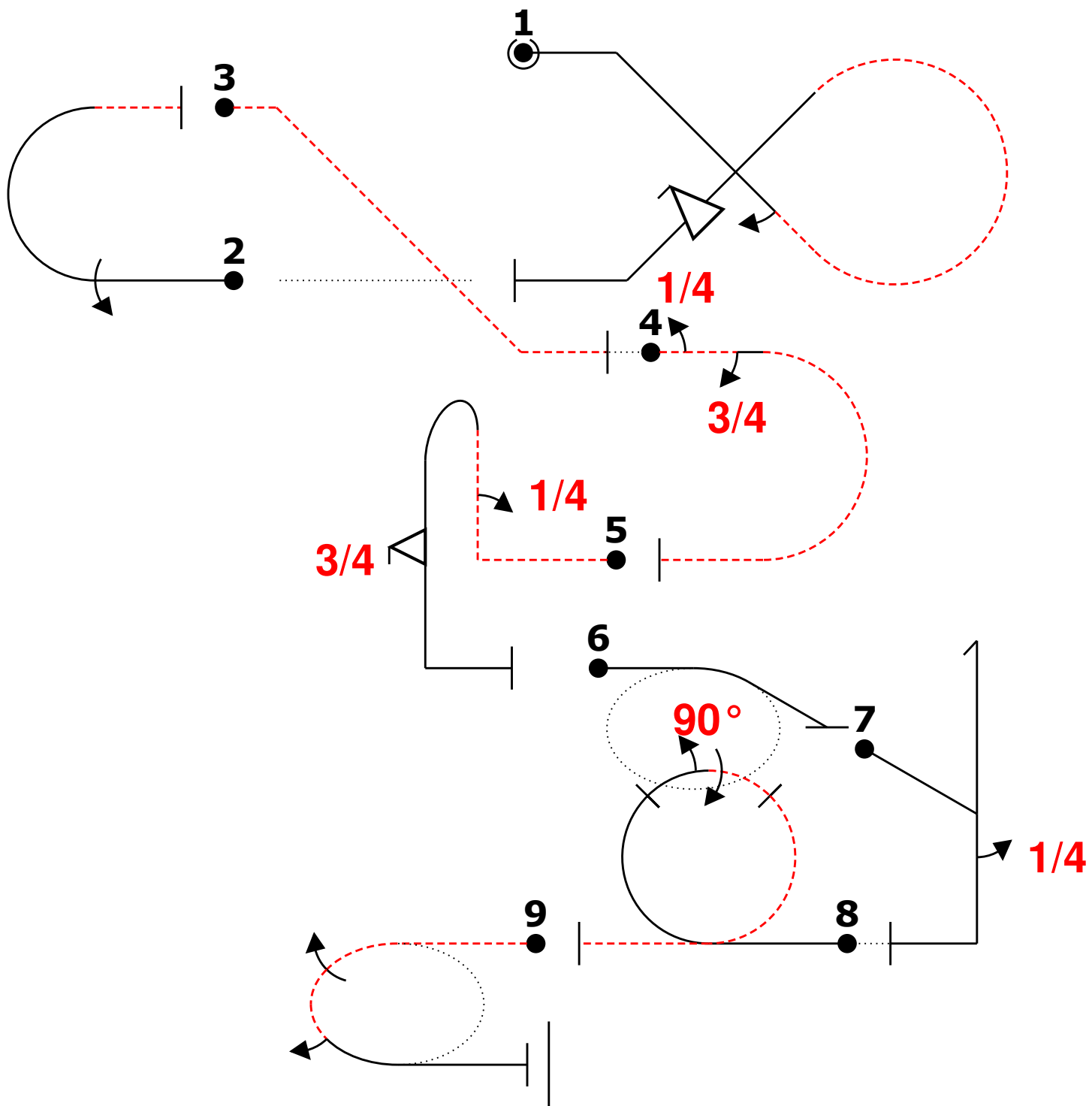
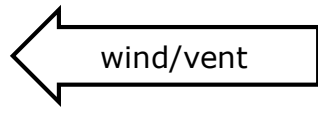

Michal Klimaszewski Pilot
 S1 SP-3532 A/C



WGAC 2024		Form B
Pilot ID	CIVA Glider Unlimited Free	Flight #

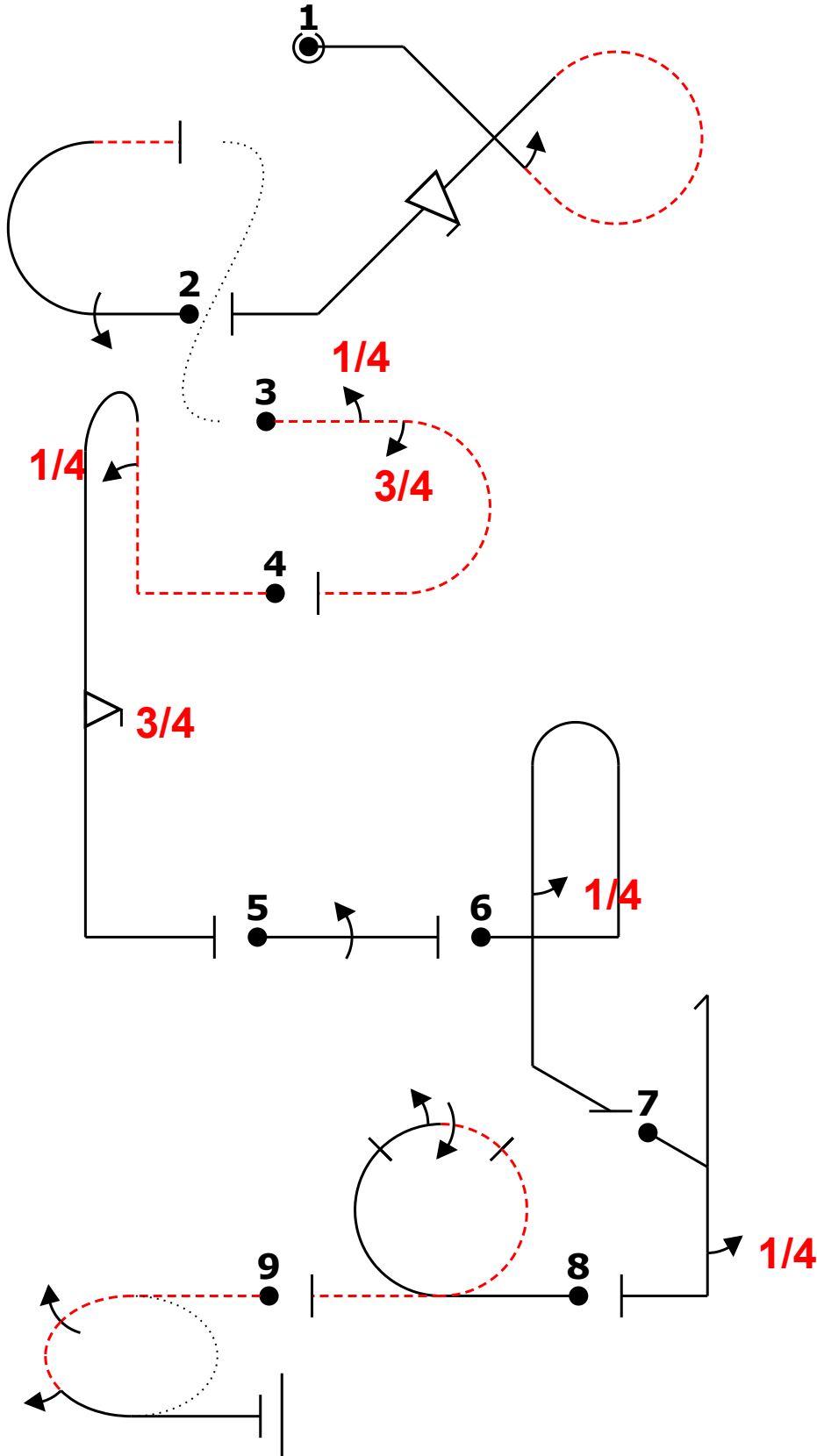
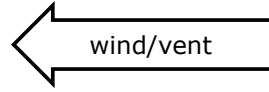

Karel Krobath Pilot
 S1 Swift F-CHBA A/C



Pilot ID		Form B
CIVA Glider Unlimited Free		Flight #

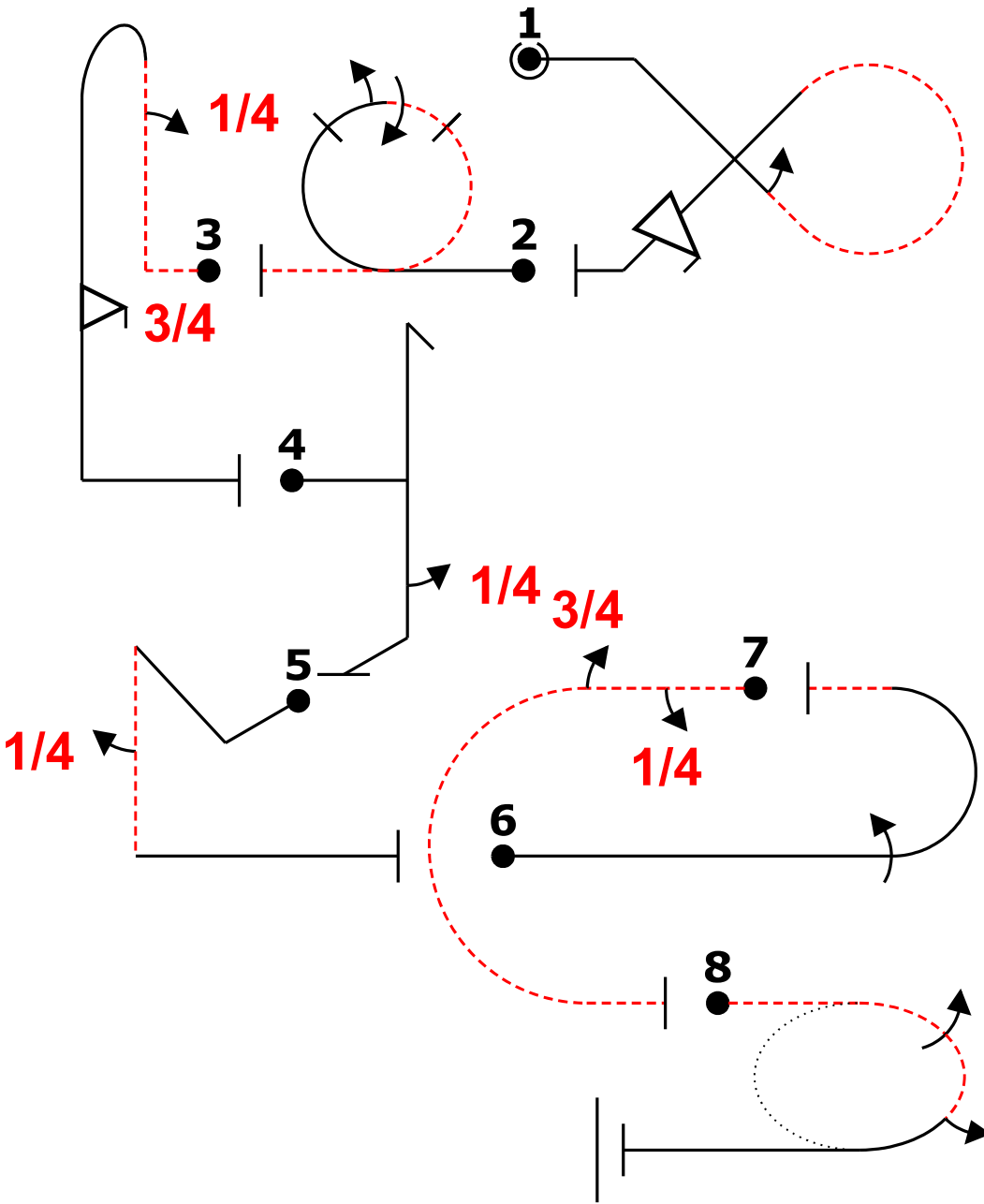

Glider			
Fig	Aresti	K	
1 C	7.3.2.3	17	39
	9.1.4.2	6	
	9.9.4.4	16	
2 A	7.4.2.1	12	30
	9.1.3.2	6	
	9.1.3.4	12	
3 B	8.4.4.2	14	37
	9.1.1.1	9	
	9.9.5.3	14	
4 F	5.2.1.1	17	20
	9.1.5.1	3	
5 Add.	1.2.1.1	13	10
	9.1.5.1	3	
6 G	7.2.1.1	6	18
	9.1.3.4	12	
7 E	7.2.3.4	9	21
	9.1.3.1	3	
	9.1.3.3	9	
8 D	2.2.3.4	35	35
Total K = 210			
(max K = 210)			

Miroslav ČERVENKA Pilot
Swift S1 OK-2151 A/C



Piloten ID		CIVA Glider Unlimited Free		Form B
				Flug #

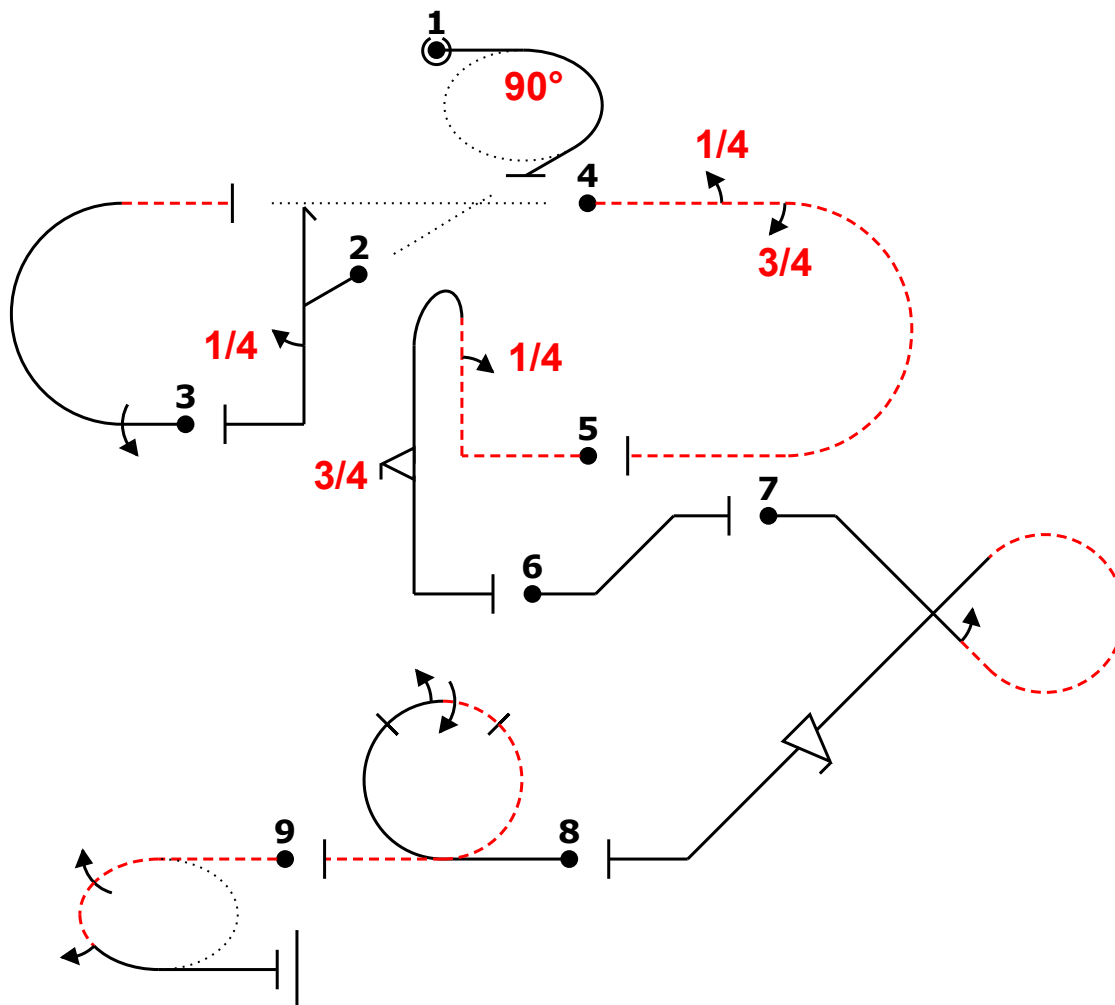
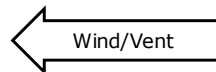

Segelflug				
Fig	Aresti	K		
1 Add.	2.1.1.1	3	5	
2	5.2.1.1 F 9.1.5.1	17 3	20	
3	7.2.1.1 G 9.1.3.4	6 12	18	
4 E	7.2.3.4 9.1.3.1 9.1.3.3	9 3 9	21	
5 B	8.4.4.2 9.1.1.1 9.9.5.3	14 9 14	37	
6 Add.	1.1.2.1	7	5	
7 C	7.3.2.3 9.1.4.2 9.9.4.4	17 6 16	39	
8 A	7.4.2.1 9.1.3.2 9.1.3.4	12 6 12	30	
9 D	2.2.3.4	35	35	
Total K = 210 (max K = 210)				

"@L" j (-5,3) "@F" "" h",4" "G" 4% "1m- [14,0] 6% "E" -4,3a~ "@B" -",4b,3f" "+ "L" -3% d "@C" '+2ig.' 'f.. "A" o2,1- "@D" -2jo15

S. Dirlam Pilot
Swift S-1 D-9590
Flugzeug



WGAC 2024		Form B
Pilot ID	CIVA Glider Unlimited Free	Flight #

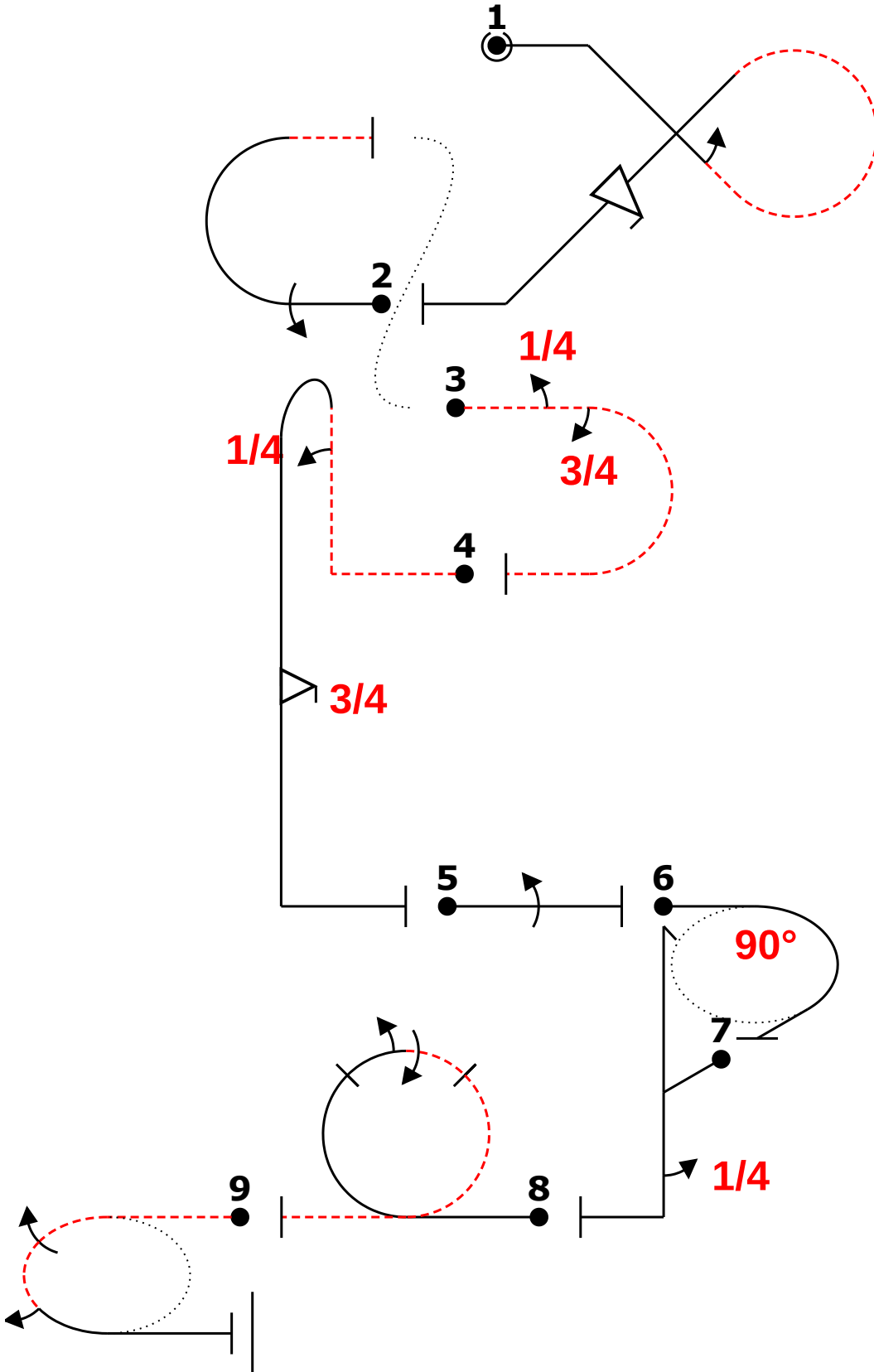
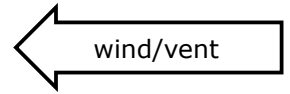

Glider			
Fig	Aresti	K	
1 C	7.3.2.3	17	39
	9.1.4.2	6	
	9.9.4.4	16	
2 G	7.2.1.1	6	18
	9.1.3.4	12	
3 E	7.2.3.4	9	21
	9.1.3.1	3	
	9.1.3.3	9	
4 B	8.4.4.2	14	37
	9.1.1.1	9	
	9.9.5.3	14	
5 Add.	1.1.1.1	2	5
	9.1.3.4	12	
6 Add.	2.1.1.1	3	5
7 F	5.2.1.1	17	20
	9.1.5.1	3	
8 A	7.4.2.1	12	30
	9.1.3.2	6	
	9.1.3.4	12	
9 D	2.2.3.4	35	35
Total K = 210 (max K = 210)			

Bernhard Behr Pilot
 S1 Swift F-CHBA A/C



WGAC 2024 Oschatz 2024		Form B
Pilot ID	CIVA Glider Unlimited Free	Flight #

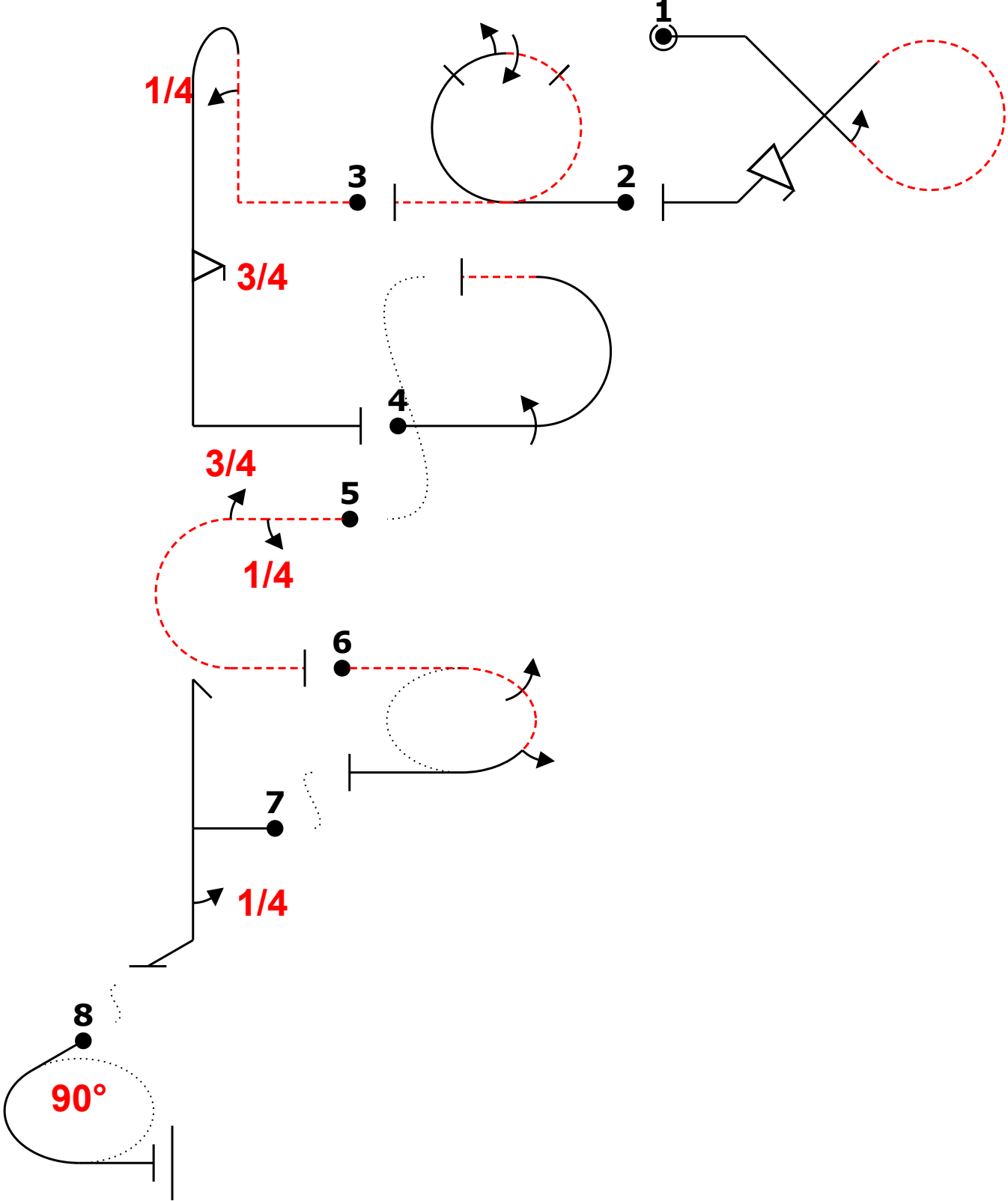
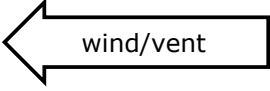

"@C" 2igf "@A" o2,1- "@B" -4b.'3f.'+ "@G" .1m- (-2,13) "@E" -4,3a- "@D" -2jo15 (0,3) "@F" h4 (0,2) "@L" j

Jens Hohmann Pilot
 Swift S1 D-5542 A/C



WGAC Oschatz 2024		Form B
Pilot ID	CIVA Glider Unlimited Free	Flight #

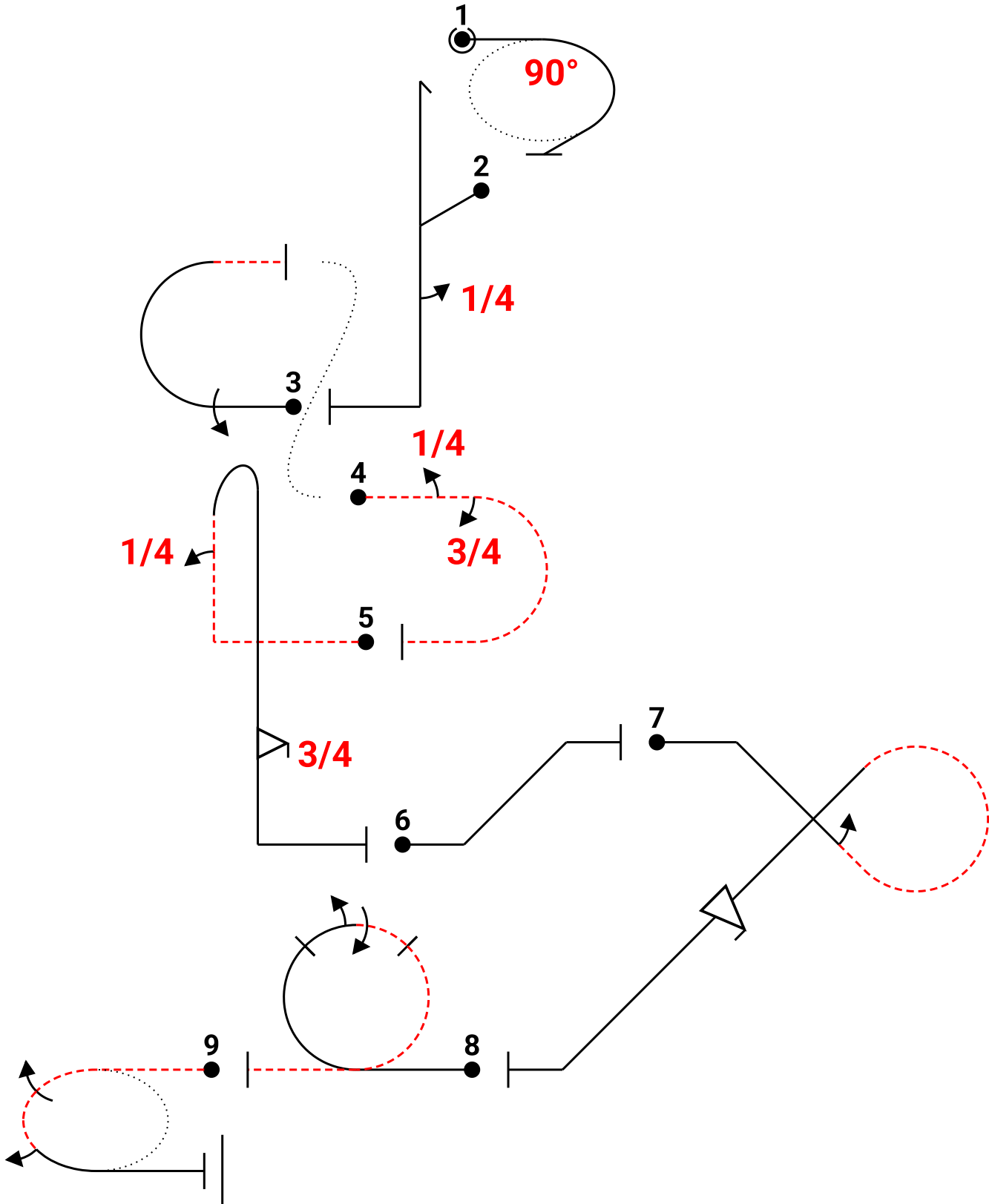
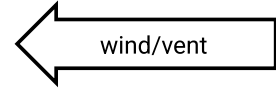

Michael Spitzer Pilot
 Swift D-3735 A/C



		Form B
Pilot ID	CIVA Glider Unlimited Programme 3	Flight #

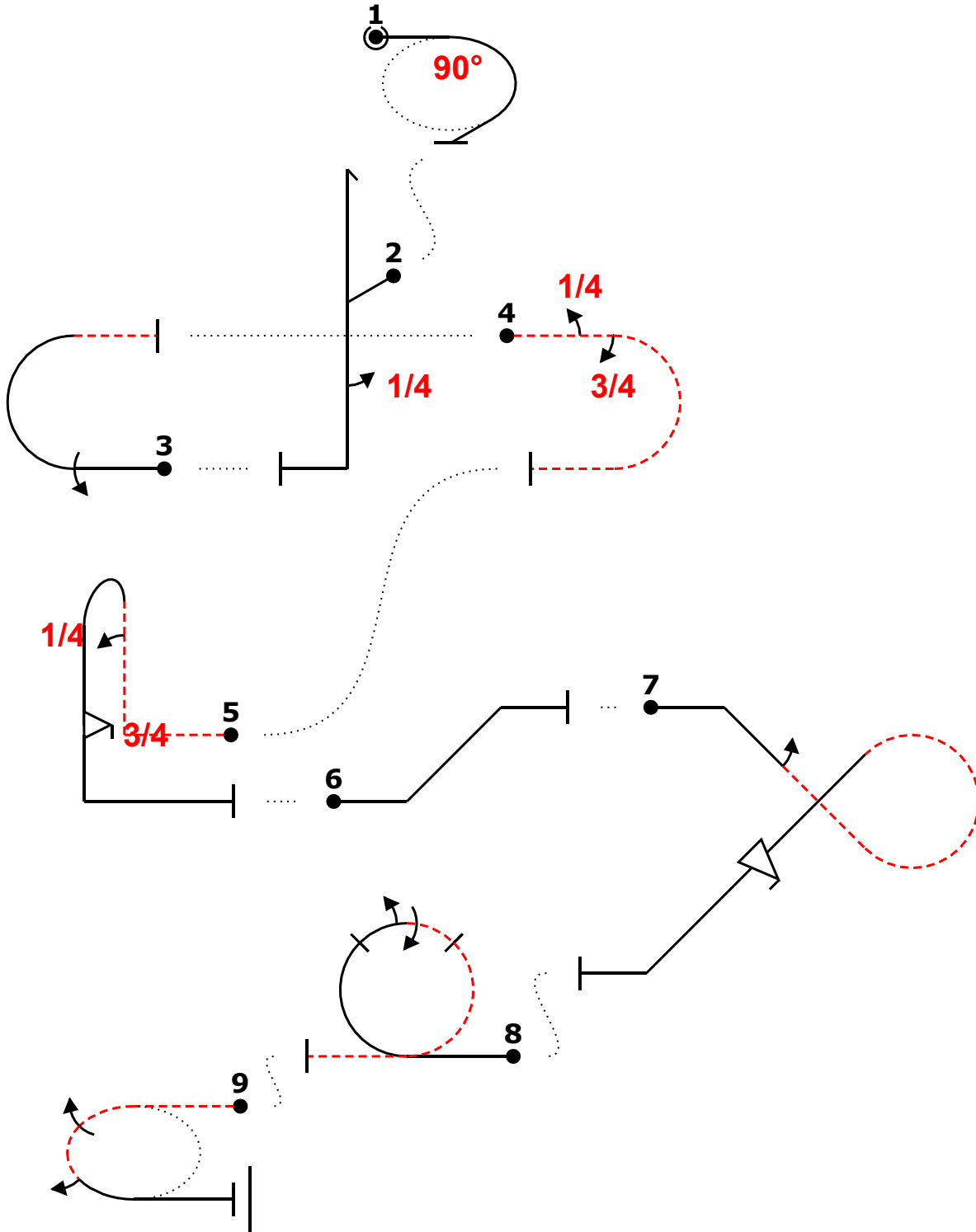
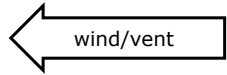

Glider			
Fig	Aresti	K	
1	2.1.1.1	3	5
Add.			
2	5.2.1.1 F 9.1.5.1	17 3	20
3	7.2.1.1 G 9.1.3.4	6 12	18
4	7.2.3.4 E 9.1.3.1 9.1.3.3	9 3 9	21
5	8.4.4.2 B 9.1.1.1 9.9.5.3	14 9 14	37
Add.			
6	1.1.2.1	7	5
7	7.3.2.3 C 9.1.4.2 9.9.4.4	17 6 16	39
8	7.4.2.1 A 9.1.3.2 9.1.3.4	12 6 12	30
9	2.2.3.4 D	35	35
Total K = 210		(max K = 210)	

Wolfgang Schieck
Pilot
Swift D-9590
A/C

Programme 3



WGAC Oschatz 2024		Form B
Pilot ID	CIVA Glider Unlimited Programme 3	Flight #

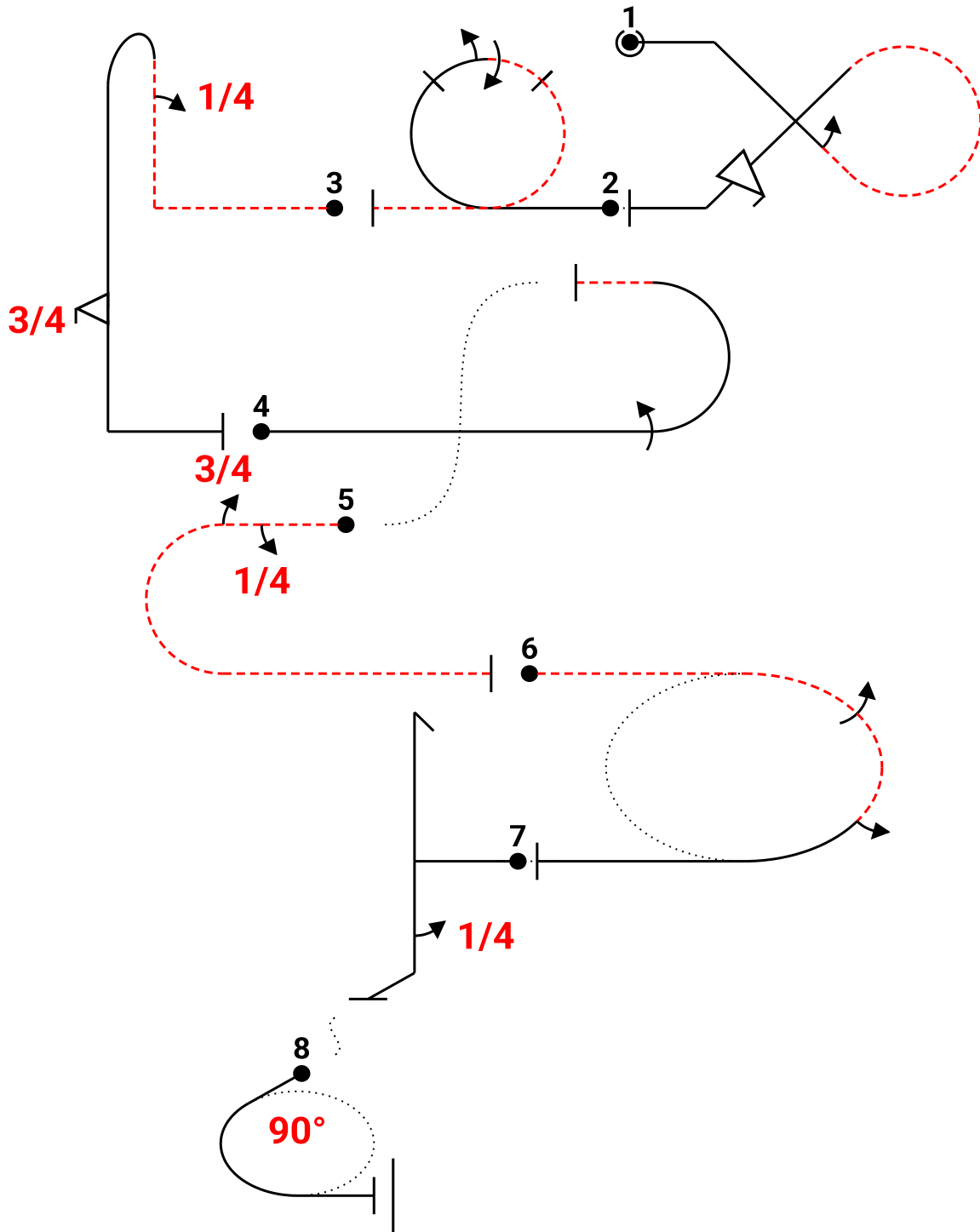
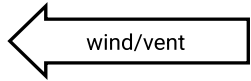

Glider			
Fig	Aresti	K	
1 C	7.3.2.3	17	39
	9.1.4.2	6	
	9.9.4.4	16	
2 A	7.4.2.1	12	30
	9.1.3.2	6	
	9.1.3.4	12	
3 B	8.4.4.2	14	37
	9.1.1.1	9	
	9.9.5.3	14	
4 G	7.2.1.1	6	18
	9.1.3.4	12	
5 E	7.2.3.4	9	21
	9.1.3.1	3	
	9.1.3.3	9	
6 D	2.2.3.4	35	35
7 F	5.2.1.1	17	20
	9.1.5.1	3	
8 Add.	2.1.1.1	3	10
Total K = 210 (max K = 210)			

Check: 2-8-2024 13:09 OpenAero 2024.1.9 2024 glider-civa unlimited programme 3 Sequence has errors:
 Manually check that first 3 figures have no more than 110 K total
 "@C" 2igf (3,0) "@A" o2,1- "@B" ...,4b...,3f'' "@G"1m (.8,13) "@E" .4,3a---- "@D" 8% _2jo15 (3,0) "@F" -h4 (0,2) "@L" j

Robin Kemter Pilot
 Swift S1b D-7125 A/C